

KOBOLD Messring GmbH

Manufacturer of
Innovative Instrumentation

Product Summary



- Flow
- Pressure
- Level
- Temperature
- pH-Value/Redox
- Conductivity
- Humidity
- Turbidity
- Density



www.kobold.com

measuring
•
monitoring
•
analysing



Production Plants
of the KOBOLD Group

Hofheim, Germany



Kelkheim-Fischbach, Germany



Sindelfingen, Germany



Cologne, Germany



Pittsburgh, USA



Barcelona, Spain





Flowmeters/-switches

Variable Area-Plastic - Low Volume
Polycarbonate/brass,
Polysulfone/stainless steel
Model: KSV



Water: 0.25 - 1.5 l/h ... 10 - 80 l/h
Air: 20 - 80 NI/h ... 0.5 - 2.5 Nm³/h
t_{max} 120 °C; p_{max} 6 bar
Connection: 1/8" NPT female thread
Accuracy: ± 6 % of full scale

Variable Area - Plastic - Low Volume
Acrylic
Model: KFR



Water: 5 - 50 ml/min ... 5 - 75 l/min
Air: 0.05 - 0.5 NI/min ... 400 - 4000 NI/min
t_{max} 65 °C; p_{max} 6,5 bar
Connection: 1/8" NPT, 1" NPT female thread
Accuracy: ± 2 - 5 % of full scale

Variable Area - Plastic
Trogamide, Polysulfone, PVDF
Model: KSK



Water: 1.5 - 11 l/h ... 100 - 1000 l/h
Air: 0.15 - 0.45 Nm³/h ... 20 - 105 Nm³/h
t_{max} 140 °C; p_{max} PN 10
Connection:
G 1/4...1 female, glue-in connection
Accuracy: Cl. 4 according to VDI

Variable Area - Plastic
Trogamide, Polysulfone
Model: KSM



Water: 15 - 150 l/h ... 8000 - 60000 l/h
Air: 0,8 - 5 Nm³/h ... 300 - 2500 Nm³/h
t_{max} 100 °C; p_{max} 16 bar
Connection: G 1/2...3/2 female/male thread
Accuracy: Cl. 4 according to VDI

Variable Area - Low Volume - Switch
Stainless steel
Model: KSR, SVN



Water: 2 - 250 ml/min
Air: 3 - 360 NI/h
t_{max} 70 °C; p_{max} 16 bar
Connection: G 1/4, 1/4" NPT female thread

Variable Area - Low Volume
Stainless steel
Model: KDF-9/KDG-9



Water: 0.02 - 0.25 l/h ... 10 - 100 l/h
Air: 2 - 20 NI/h... 300 - 3000 NI/h
t_{max} 100 °C; p_{max} 16 bar
Connection: G 1/4, 1/4" NPT female thread
Accuracy: ± 3 % q_G = 50 %

Variable Area - Low Volume
Stainless steel
Model: KDF-2/KDG-2



Water: 0.25 - .5 l/h ... 16 - 160 l/h
Air: 0,5 - 5 NI/h... 500 - 5000 NI/h
t_{max} 100 °C; p_{max} 16 bar
Connection: G 1/4, 1/4" NPT female thread
Accuracy: ± 2.5 % q_G = 50 %

Variable Area - Glass Cone - Thread Connection
Stainless steel, PVC
Model: URM



Water: 0.25 - 2.5 l/h ... 2500 - 25000 l/h
Air: 3.2 - 32 NI/h ... 32 - 320 Nm³/h
t_{max} 100 °C; p_{max} 16 bar
Connection: G 3/8...3 male, G 1/4...G 1 1/2 female, DIN 11851, hose connection
Accuracy: Cl. 4 according to VDI

Variable Area - Glass Cone
PVC
Model: URB



Water: 10 - 100 l/h ... 100 - 1000 l/h
Air: 0.32 - 3.2 Nm³/h ... 3.2 - 32 Nm³/h
t_{max} 65 °C; p_{max} 6 bar
Connection: G 1/2...1 1/4 male thread
Accuracy: Cl. 4 according to VDI

Variable Area - Glass Cone
Stainless steel, POM-C
Model: UVR, UTR



Water: 10 - 100 l/h ... 200 - 2000 l/h
Air: 0.1 - 1 Nm³/h ... 5 - 50 Nm³/h
t_{max} 100 °C; p_{max} 16 bar
Connection: G 3/8, G 1/2 female thread
Accuracy: Cl. 4 according to VDI

Variable Area - Glass Cone - Loose Flange
PVC, PTFE
Model: URL



Water: 1 - 10 l/h ... 250 - 2500 l/h
Air:
0.025 - 0.25 Nm³/h ... 10 - 100 Nm³/h
t_{max} 100 °C; p_{max} 6 bar
Connection: flange DN 15...40
Accuracy: Cl. 4 according to VDI

Variable Area - Glass Cone
Stainless steel, PVDF, PVC
Model: V31



Water: 3 - 30 l/h ... 1000 - 10000 l/h
Air: 36 - 360 NI/h ... 18 - 180 Nm³/h
t_{max} 80 °C; p_{max} 15 bar
Connection: G 1/4 ... 2 female, flange DN 10...65, ANSI 1/2" ... 2 1/2"
Accuracy: Cl. 1,6/2,5 according to VDI





Flowmeters/-switches

Variable Area - Glass Cone - Fixed or Loose Flange

Stainless steel
Model: URK



Water: 1 - 10 l/h ... 15000 - 50000 l/h
Air: 0.02 - 0.2 Nm³/h ... 50 - 500 Nm³/h
t_{max} 100 °C; p_{max} 16 bar
Connection: flange DN 15...80, ANSI ½" ...3"
Accuracy: Cl. 4 according to VDI

Variable Area - Glass Cone for Gas burners

Brass
Model: UTS



Air: 10 - 100 NI/h ... 0.3 - 3 Nm³/h
t_{max} 60 °C; p_{max} 3 bar
Connection: M 18x 1.5, axial special connection or G ¼ for horizontal mounting
Accuracy: Cl. 4 according to VDI

Variable Area

Brass, stainless steel
Model: DSV-1



Water: 0.25 - 1.25 l/min ... 10 - 130 l/min
Air: on request
t_{max} 100 °C; p_{max} 10 bar
Connection: G ¼...1¼, ¼...1¼" NPT female
Accuracy: ±4 % of full scale

Variable Area

Brass, stainless steel
Model: DSV-3



Water: 0.25 - 1.25 l/min ... 10 - 130 l/min
Air: on request
t_{max} 100 °C; p_{max} 10 bar
Connection: G ¼...1¼, ¼...1¼" NPT female
Accuracy: ±4 % of full scale

Variable Area Switch - Low Volume

PVC
Model: SWK-13



Water: 0.2 - 0.8 l/min ... 13 - 24 l/min
Air: on request
t_{max} 60 °C; p_{max} 6 bar
Connection: G ½ female thread
Genauigkeit: ±4 % of full scale

Variable Area Switch - Low Volume

Brass, stainless steel
Model: SWK-1



Water: 0.05 - 0.1 l/min ... 13 - 24 l/min
Air: on request
t_{max} 100 °C; p_{max} 250 bar
Connection: G ½ female thread
Genauigkeit: ±4 % of full scale

Variable Area - Low Volume

Brass, stainless steel
Model: SWK-2



Water: 0.05 - 0.1 l/min ... 13 - 24 l/min
Air: on request
t_{max} 100 °C; p_{max} 250 bar
Connection: G ½ female thread
Accuracy: ±4 % of full scale

Variable Area - All Metal - Low Volume

Stainless steel
Model: KDS/KDS-R



Water: 0.1 - 1 l/h ... 20 - 200 l/h
Air: 5 - 50 NI/h ... 600 - 6000 NI/h
t_{max} 130 °C; p_{max} PN 40/63
Connection: ¼" NPT
Option: Analogue output 4 - 20 mA
Accuracy: ± 3 % q_G = 50 %

Variable Area - All Metal - Low Volume

Stainless steel
Model: BGN



Water: 0.1 - 1 l/h ... 20 - 200 l/h
Air: 5 - 50 NI/h ... 600 - 6000 NI/h
t_{max} 130 °C; p_{max} PN 40 (higher on request)
Connection: DN 10, DN 15, DN 25, ANSI ½", ¾", 1"
Option: Analogue output 4 - 20 mA
Accuracy: ± 3 % q_G = 50 %

Variable Area - All Metal

Stainless steel, PTFE/stainless steel special material on request
Model: BGN



Water: 0.5 - 5 l/h ... 13000 - 130000 l/h
Air: 0.015 - 0.15 Nm³/h ... 240 - 2400 Nm³/h
t_{max} 350 °C; p_{max} PN 40 (higher on request)
Connection: flange DN 15...150, ANSI ½"...6"
Options: Analogue output, Bus-Interface, heating coat
Accuracy: ± 1.6 % q_G = 50 %

Variable Area - All Metal

Stainless steel, special material on request
Model: BGN-High Pressure



Water: 0.5 - 5 l/h ... 13000 - 130000 l/h
Air: 0,015 - 0,15 Nm³/h ... 240 - 2400 Nm³/h
t_{max} 350 °C; p_{max} 600 bar
Connection: flange DN 15...150, ANSI ½"...6", thread, special connections
Options: Analogue output, BUS-Interface, Heating coat
Accuracy: ± 1.6 - 2.2 % of full scale

Variable Area All Metal - Mounting Position Independent

Stainless steel, PTFE/stainless steel special material on request
Model: BGF

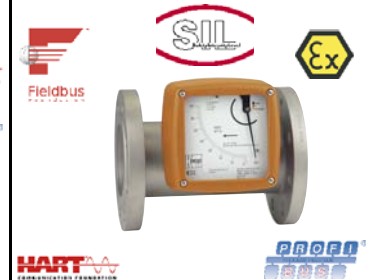

Water: 10 - 100 l/h ... 4000 - 40000 l/h
Air: 0.3 - 3 Nm³/h ... 110 - 1100 Nm³/h
t_{max} 200 °C; p_{max} PN 40
Connection: flange DN 15...80, ANSI ½"...3"
Accuracy: ±2 % q_G = 50 %





Flowmeters/-switches

Variable Area - All Metal

Brass, stainless steel

Model: DSS



Water: 0.05 - 1 l/min ... 10 - 110 l/min
 t_{max} 100°C; p_{max} 350 bar
Connection:
G 1/4...1/4, 1/4...1/4" NPT female thread
Accuracy: \pm 5 % of full scale

Variable Area - All Metal

Brass, stainless steel

Model: SMV



Water: 0.1 - 1 l/min ... 10 - 110 l/min
 t_{max} 100°C; p_{max} 350 bar
Connection:
G 1/4...1/4, 1/4...1/4" NPT female thread
Accuracy: \pm 5 % of full scale

Displacer All Metal

Brass, stainless steel

Model: SMO, SMW



Water: 0.2 - 3 l/min ... 10 - 120 l/min
 t_{max} 100°C; p_{max} 350 bar
Connection:
G 1/4...1, 1/4...3/4" NPT female thread
Accuracy: \pm 5 % of full scale

Displacer Switch - Mounting Position Independent

Brass, stainless steel

Model: SMN



Water: 1 - 100 l/min
 t_{max} 100°C; p_{max} 350 bar
Connection: 1" NPT, G 1 female thread
Accuracy: \pm 5 % of full scale

Viscosity Compensated - Plastic

Polysulfone

Model: VKP



Water: 2 - 20 l/min ... 20 - 100 l/min
Oil: 1 - 18 l/min ... 10 - 75 l/min
 t_{max} 120°C; p_{max} 16 bar
Connection: G 1/2, G 3/4 female/male thread,
G 1, 1" NPT male thread, soldered or glue-in
connection
Accuracy: \pm 5 % of full scale

Viscosity Compensated

Brass, stainless steel

Model: VKG



Viscosity range: 1 - 540 mm²/s
Oil: 0.1 - 0.45 l/min ... 5 - 80 l/min
 t_{max} 100°C; p_{max} 12 bar
Connection: G 1/4...1, 1/4...1" NPT
Accuracy: \pm 4 % of full scale

Viscosity Compensated - All Metal

Brass, stainless steel

Model: VKM



Viscosity range: 1 - 540 mm²/s
Oil: 0.01 - 0.07 l/min ... 8 - 80 l/min
 t_{max} 100°C; p_{max} 350 bar
Connection: G 1/4...1, 1/4...1" NPT
Accuracy: \pm 4 % of full scale

Viscosity Compensated - All Metal

Brass, stainless steel

Model: VKM with ADI-1



Viscosity range: 1 - 540 mm²/s
Oil: 0.01 - 0.063 l/min ... 8 - 72 l/min
 t_{max} 100°C; p_{max} 350 bar
Connection: G 1/4...1, 1/4...1" NPT
Accuracy: \pm 4 % of full scale

Viscosity Compensated - All Metal

Brass

Model: VKA



Viscosity range: 30 - 540 mm²/s
Oil: 0.1 - 0.4 l/min ... 30 - 100 l/min
 t_{max} 100°C; p_{max} 250 bar
Connection: G 1/4...1, 1/2" NPT, 3/4" NPT
female thread
Accuracy: \pm 4 % of full scale

Manifold Valves for Multiple Installation

Aluminium

Model: BVB



t_{max} 100°C; p_{max} PN 64
Connection: G 1/2 female thread

Paddle Switch

Brass, stainless steel

Model: PSR



Water:
2.3 - 4.7 l/min ... 47.6 - 67.2 l/min
 t_{max} 110°C; p_{max} 250 bar
Connection:
G 1/4...1/2, 1/4...1/2" NPT female thread

Paddle Switch

Brass, stainless steel

Model: PSE

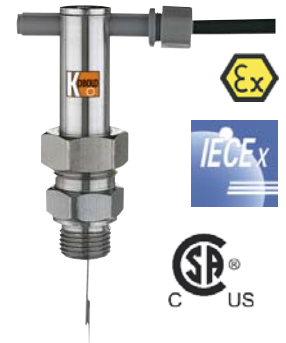

Water: 68 - 90 l/min ... 383 - 533 l/min
 t_{max} 110°C; p_{max} 250 bar
Connection: G 1/2, 1/2" NPT male thread





Flowmeters/-switches

Paddle Switch - Polysulfone

Polysulfone

Model: PPS



Water: 18 - 36 l/min ... 72 - 108 l/min
 t_{max} 105 °C; p_{max} 10 bar
 Connection: G 1, 1" NPT male thread
 Accuracy: \pm 20 % of reading

Paddle Switch - Air

Brass

Model: LPS



Air: 1 - 8 m/s
 t_{max} 85 °C; p_{max} atmospheric
 Connection: connection plate

Paddle Bellow Switch

Brass, stainless steel

Model: FPS



Water:
 0.17 - 0.85 m³/h ... 72,6 - 165,7 m³/h
 t_{max} 120 °C; p_{max} 30 bar
 Connection:
 G ½, G ¾ IG, R 1, 1" NPT male thread

Paddle Bellow Switch

Brass, stainless steel, PVC

Model: DWN



Water: 1 - 5 l/min ... 900 - 3600 m³/h
 t_{max} 100 °C; p_{max} PN 16
 Connection: G ¾...2, ¾...2" NPT female thread, flange DN 10...50, ANSI ¾...2", weld-on flange DN 40...500
 Accuracy: \pm 3 - 5 % of full scale

Paddle Bellow Meter/Switch

Brass, Stainless steel, PVC

Model: DWU



Water: 1 - 5 l/min ... 900 - 3600 m³/h
 t_{max} 100 °C; p_{max} PN 16
 Connection: G ¾...2, ¾...2" NPT female thread, flange DN 10...50, ANSI ¾...2", weld-on flange DN 40...500
 Accuracy: \pm 3 - 5 % of full scale

Paddle Torsion - Meter/Switch

Aluminium-bronze, stainless steel

Model: DPT...C3



Water: 5 - 30 l/min ... 850 - 1900 l/min
 t_{max} 80 °C; p_{max} PN 40
 Connection:
 G ¾...3, ¾...3" NPT female thread
 Accuracy: \pm 3 % of full scale

Paddle Torsion - Meter/Switch

Aluminium-bronze, stainless steel

Model: DPT...K



Water: 5 - 30 l/min ... 850 - 1900 l/min
 t_{max} 80 °C; p_{max} PN 40
 Connection: G ¾...3, ¾...3" NPT female thread
 Accuracy: \pm 3 % of full scale

Baffle Flap Meter/Switch

Brass, stainless steel, PVC

Model: DWD



Water: 1 - 10 l/min ... 360 - 3600 m³/h
 t_{max} 120 °C; p_{max} 25 bar
 Connection: G ¾...2, ¾...2" NPT female, flange DN 10...50, ANSI ¾...2", weld-on flange DN 40...500
 Accuracy: \pm 1.5 % of full scale

Flap Meter/Switch

Steel, stainless steel, PP, PTFE, Hastelloy

Model: TSK



Water: 0.5 - 3.5 m³/h ... 200 - 1500 m³/h
 t_{max} 300 °C; p_{max} PN 40
 Connection: wafer flange DN 25...500, ANSI 1"...20"
 Accuracy:
 from \pm 2 % of reading + 1 % of full scale

Flow, Humidity and Temperature Hand-Held Measuring Unit

Model: HND-F115



Measuring range: 0.05...5 m/s Water
 0.55...20 m/s Air
 Humidity: 0...100% rH
 Temperature: -40...+120 °C, -80...250 °C
 Accuracy: from \pm 0.1%

Turbine Wheel - Pulse Output

Brass, stainless steel, PPO

Model: DRS...F5



Water: 2 - 40 l/min
 t_{max} 150 °C; p_{max} 200 bar
 Connection: G ½, G ¾, ¾" NPT
 Accuracy: \pm 1.5 % of full scale

Turbine Wheel - Analogue Output

Brass, stainless steel, PPO

Model: DRS...L3



Water: 2 - 40 l/min
 t_{max} 80 °C; p_{max} 200 bar
 Connection: G ½, G ¾, ¾" NPT
 Accuracy: \pm 1.5 % of full scale



Flowmeters/-switches

Turbine Wheel - Analogue Output
Brass, stainless steel, PPO
Model: DRS-...L4 with AUF



Water: 2 - 40 l/min
t_{max} 80 °C; p_{max} 200 bar
Connection: G 1/2, G 3/4, 3/4" NPT
Accuracy: ± 1.5 % of full scale

Turbine Wheel - Pointer Indicator
Brass, stainless steel, PPO
Model: DRS-...Z3



Water: 2 - 40 l/min
t_{max} 80 °C; p_{max} 200 bar
Connection: G 1/2, G 3/4, 3/4" NPT
Accuracy: ± 1.5 % of full scale

Turbine Wheel - Compact Electronic
Brass, stainless steel, PPO
Model: DRS-...C3



Water: 2 - 40 l/min
t_{max} 80 °C; p_{max} 200 bar
Connection: G 1/2, G 3/4, 3/4" NPT
Accuracy: ± 1.5 % of full scale

Turbine Wheel - Counter
Brass, stainless steel, PPO
Model: DRS with ZED



Water: 2 - 40 l/min
t_{max} 150 °C; p_{max} 200 bar
Connection: G 1/2, G 3/4, 3/4" NPT
Accuracy: ± 1.5 % of full scale

Turbine Wheel - Pulse Output
PVC, PVDF
Model: TUR-1



Water: 0.2 - 5 m³/h ... 2.5 - 100 m³/h
t_{max} 70 °C; p_{max} 10 bar
Connection: flange DN 25...100
Accuracy: ± 1 % of full scale

Turbine Wheel - Analogue Output
PVC, PVDF
Model: TUR-2...M



Water: 0.2 - 5 m³/h ... 2.5 - 100 m³/h
t_{max} 70 °C; p_{max} 10 bar
Connection: flange DN 25...100
Accuracy: ± 1 % of full scale

Turbine Wheel - Pointer Indicator
PVC, PVDF
Model: TUR-2...Z3



Water: 0.2 - 5 m³/h ... 2.5 - 100 m³/h
t_{max} 70 °C; p_{max} 10 bar
Connection: flange DN 25...100
Accuracy: ± 1 % of full scale

Turbine Wheel - Compact Electronics
PVC, PVDF
Model: TUR-2...C3



Water: 0.2 - 5 m³/h ... 2.5 - 100 m³/h
t_{max} 70 °C; p_{max} 10 bar
Connection: flange DN 25...100
Accuracy: ± 1 % of full scale

Turbine Wheel - Digital Display
PVC, PVDF
Model: TUR-2...K



Water: 0.2 - 5 m³/h ... 2.5 - 100 m³/h
t_{max} 70 °C; p_{max} 10 bar
Connection: flange DN 25...100
Accuracy: ± 1 % of full scale

Turbine Wheel - Pulse - Analogue Output
Aluminium-bronze, stainless steel
Model: DPE-...F, DPE-...L

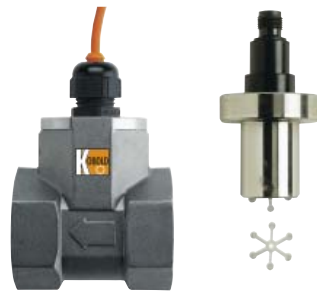

Water: 5 - 30 l/min ... 50 - 750 l/min
t_{max} 80 °C; p_{max} PN 40
Connection: G 1/2...3, 1/2...3" NPT female thread, weld-on sleeve DN 25...80
Accuracy: ± 2.5 % of full scale

Turbine Wheel - Analogue Output
Aluminium-bronze, stainless steel
Model: DPE with AUF



Water: 5 - 30 l/min ... 50 - 750 l/min
t_{max} 80 °C; p_{max} PN 40
Connection: G 1/2...3, 1/2...3" NPT female thread, weld-on sleeve DN 25...80
Accuracy: ± 2.5 % of full scale

Turbine Wheel - Pointer Indicator
Aluminium-bronze, stainless steel
Model: DPE-...Z3



Water: 5 - 30 l/min ... 50 - 750 l/min
t_{max} 80 °C; p_{max} PN 40
Connection: G 1/2...3, 1/2...3" NPT female thread, weld-on sleeve DN 25...80
Accuracy: ± 2.5 % of full scale





Flowmeters/-switches

Turbine Wheel - Compact Electronics

Aluminium-bronze, stainless steel
Model: DPE-...C3



Water: 5 - 30 l/min ... 50 - 750 l/min
 t_{max} 80 °C; p_{max} PN 40
Connection: G ½...3, ½...3" NPT female thread, weld-on sleeve DN 25...80
Accuracy: ± 2.5 % of full scale

Turbine Wheel - Digital Display

Aluminium-bronze, stainless steel

Model: DPE with ADI-1



Water: 5 - 30 l/min ... 50 - 750 l/min
 t_{max} 80 °C; p_{max} PN 40
Connection: G ½...3, ½...3" NPT female thread, weld-on sleeve DN 25...80
Accuracy: ± 2.5 % of full scale

Turbine Wheel - Dosing Electronics

Aluminium-bronze, stainless steel
Model: DPE with ZED



Water: 5 - 30 l/min ... 50 - 750 l/min
 t_{max} 80 °C; p_{max} PN 40
Connection: G ½...3, ½...3" NPT female thread, weld-on sleeve DN 25...80
Accuracy: ± 2.5 % of full scale

Turbine Wheel - Pulse - Analogue Output

Aluminium-bronze, stainless steel
Model: DRB-...F, DRB-...L

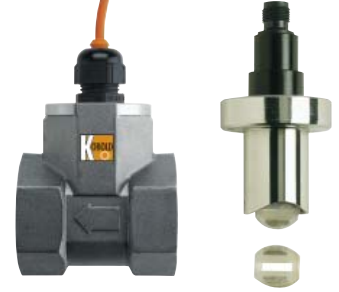

Water: 5 - 30 l/min ... 50 - 750 l/min
 t_{max} 80 °C; p_{max} 16 bar
Connection: G ½...3, ½...3" NPT female thread, weld-on sleeve DN 25...80
Accuracy: ± 3 % of full scale

Turbine Wheel - Analogue Output

Aluminium-bronze, stainless steel
Model: DRB with AUF



Water: 5 - 30 l/min ... 50 - 750 l/min
 t_{max} 80 °C; p_{max} 16 bar
Connection: G ½...3, ½...3" NPT female thread, weld-on sleeve DN 25...80
Accuracy: ± 3 % of full scale

Turbine Wheel - Pointer Indicator

Aluminium-bronze, stainless steel
Model: DRB-...Z3



Water: 5 - 30 l/min ... 50 - 750 l/min
 t_{max} 80 °C; p_{max} 16 bar
Connection: G ½...3, ½...3" NPT female thread, weld-on sleeve DN 25...80
Accuracy: ± 3 % of full scale

Turbine Wheel - Compact Electronics

Aluminium-bronze, stainless steel
Model: DRB-...C3



Water: 5 - 30 l/min ... 50 - 750 l/min
 t_{max} 80 °C; p_{max} 16 bar
Connection: G ½...3, ½...3" NPT female thread, weld-on sleeve DN 25...80
Accuracy: ± 3 % of full scale

Turbine Wheel - Digital Display

Aluminium-bronze, stainless steel
Model: DRB with ADI-1



Water: 5 - 30 l/min ... 50 - 750 l/min
 t_{max} 80 °C; p_{max} 16 bar
Connection: G ½...3, ½...3" NPT female thread, weld-on sleeve DN 25...80
Accuracy: ± 3 % of full scale

Turbine Wheel - Dosing Electronics

Aluminium-bronze, stainless steel
Model: DRB with ZED



Water: 5 - 30 l/min ... 50 - 750 l/min
 t_{max} 80 °C; p_{max} 16 bar
Connection: G ½...3, ½...3" NPT female thread, weld-on sleeve DN 25...80
Accuracy: ± 3 % of full scale

Turbine Wheel - Pulse Output

Stainless steel
Model: TUV



Water: 0.3 - 1.5 l/min ... 35 - 400 l/min
 t_{max} 350 °C; p_{max} 640 bar
Connection: G ¼...1½ female thread
Accuracy: ± 1 % of reading

Turbine Wheel - Pulse Output

PVDF, Stainless steel
Model: SFL



Water: 0.5 - 20 l/min
 t_{max} 90 °C; p_{max} 250 bar
Connection: G ¾
Accuracy: ± 1 % of full scale

Turbine Wheel

Stainless steel
Model: DOT



Water: 0.11 - 1.1 m³/h ... 270 - 2700 m³/h
 t_{max} 150 °C; p_{max} 250 bar
Connection: G ½...2, ½...2" NPT, flange DN 15...300
Accuracy: ± 0.5 % (linearity)



Flowmeters/-switches

**Turbine Wheel Flowmeter/
Counter - Battery powered**
Nylon, aluminium, stainless steel
Model: EDM



Water: 4 - 40 l/min ... 80 - 800 l/min
 t_{max} 60 °C; p_{max} 100 bar
Connection: Rc 1/2...2 female thread
Accuracy: \pm 1.5 % of full scale

Turbine Wheel - Low Volume
Nylon, stainless steel, titanium
Model: PEL-L



Water: 0.006 - 0.1 l/min ... 0.1 - 500 l/min
 t_{max} 135 °C; p_{max} 345 bar
Connection: R 1/2...1 1/4, wafer flange
DN 40/50, glue-in connection DN 15...50
Accuracy: \pm 1.25 % of full scale

Turbine Wheel - Low Volume
Stainless steel, PVC, titanium
Model: PEL-M



Water: 1 - 65 l/min ... 10 - 500 l/min
 t_{max} 135 °C; p_{max} 345 bar
Connection: R 1/2...1 1/4, wafer flange
DN 40/50, glue-in connection DN 15...50
Accuracy: \pm 1.25 % of full scale

**Rotating Vane - Low Volume -
Pulse Output**
Brass, stainless steel
Model: DPM-...F5



Water: 0.015 - 0.7 l/min ... 0.05 - 5 l/min
 t_{max} 80 °C; p_{max} 16 bar
Connection:
G 1/8, G 1/4, 1/8" NPT, 1/4" NPT female thread
Accuracy: \pm 1 - 2.5 % of full scale

**Rotating Vane - Low Volume -
Analogue Output**
Brass, stainless steel
Model: DPM-...L3



Water: 0.015 - 0.7 l/min ... 0.05 - 5 l/min
 t_{max} 80 °C; p_{max} 16 bar
Connection:
G 1/8, G 1/4, 1/8" NPT, 1/4" NPT female thread
Accuracy: \pm 1 - 2.5 % of full scale

**Rotating Vane - Low Volume -
Analogue Output**
Brass, stainless steel
Model: DPM-...L4 with AUF



Water: 0.015 - 0.7 l/min ... 0.05 - 5 l/min
 t_{max} 80 °C; p_{max} 16 bar
Connection:
G 1/8, G 1/4, 1/8" NPT, 1/4" NPT female thread
Accuracy: \pm 1 - 2.5 % of full scale

**Rotating Vane - Low Volume -
Pointer Indicator**
Brass, stainless steel
Model: DPM-...Z3



Water: 0.015 - 0.7 l/min ... 0.05 - 5 l/min
 t_{max} 80 °C; p_{max} 16 bar
Connection:
G 1/8, G 1/4, 1/8" NPT, 1/4" NPT female thread
Accuracy: \pm 1 - 2.5 % of full scale

**Rotating Vane - Low Volume -
Compact Electronics**
Brass, stainless steel
Model: DPM-...C3



Water: 0.015 - 0.7 l/min ... 0.05 - 5 l/min
 t_{max} 80 °C; p_{max} 16 bar
Connection:
G 1/8, G 1/4, 1/8" NPT, 1/4" NPT female thread
Accuracy: \pm 1 - 2.5 % of full scale

**Rotating Vane - Low Volume -
Counter**
Brass, stainless steel
Model: DPM mit ZED



Water: 0.015 - 0.7 l/min ... 0.05 - 5 l/min
 t_{max} 80 °C; p_{max} 16 bar
Connection:
G 1/8, G 1/4, 1/8" NPT, 1/4" NPT female thread
Accuracy: \pm 1 - 2.5 % of full scale

**Rotating Vane - Low Volume -
Pulse Output**
Polypropylene
Model: DPL-...F5



Water: 0.025 - 0.5 l/min ... 1 - 25 l/min
 t_{max} 70 °C; p_{max} 10 bar
Connection:
G 1/2 male thread, hose connector
Accuracy: \pm 2.5 % of full scale

**Rotating Vane - Low Volume -
Analogue Output**
Polypropylene
Model: DPL-...L3



Water: 0.025 - 0.5 l/min ... 1 - 25 l/min
 t_{max} 70 °C; p_{max} 10 bar
Connection:
G 1/2 male thread, hose connector
Accuracy: \pm 2.5 % of full scale

**Rotating Vane - Low Volume -
Analogue Output**
Polypropylene
Model: DPL-...L4 mit AUF



Water: 0.025 - 0.5 l/min ... 1 - 25 l/min
 t_{max} 70 °C; p_{max} 10 bar
Connection:
G 1/2 male thread, hose connector
Accuracy: \pm 2.5 % of full scale





Flowmeters/-switches

Rotating Vane - Low Volume - Pointer Indicator

Polypropylene

Model: DPL-...Z3



Water: 0.025 - 0.5 l/min ... 1 - 25 l/min
 t_{max} 70 °C; p_{max} 10 bar
 Connection:
 G 1/2 male thread, hose connector
 Accuracy: \pm 2.5 % of full scale

Rotating Vane - Low Volume - Compact Electronic

Polypropylene

Model: DPL-...C3



Water: 0.025 - 0.5 l/min ... 1 - 25 l/min
 t_{max} 70 °C; p_{max} 10 bar
 Connection:
 G 1/2 male thread, hose connector
 Accuracy: \pm 2.5 % of full scale

Rotating Vane - Low Volume - Counter

Polypropylene

Model: DPL mit ZED



Water: 0.025 - 0.5 l/min ... 1 - 25 l/min
 t_{max} 70 °C; p_{max} 10 bar
 Connection:
 G 1/2 male thread, hose connector
 Accuracy: \pm 2.5 % of full scale

Rotating Vane - Low Volume

Brass, PTFE, Ryton®

Model: KFF-1, KFG-1



Water: 15 - 100 ml/min ... 1 - 10 l/min
 Air: 10 - 50 Nml/min ... 100 - 500 NI/min
 t_{max} 50 °C; p_{max} 35 bar
 Connection: Schlauchanschluss 1/8" ... 1/2"
 Accuracy: \pm 3 % of full scale

Rotating Vane - Low Volume

Brass, PTFE, Ryton®

Model: KFF-3, KFG-3



Water: 13 - 100 ml/min ... 0,2-5 l/min
 Luft: 10 - 50 Nml/min ... 2-10 NI/min
 t_{max} 50 °C; p_{max} 35 bar
 Connection: hose connection 1/8" ... 1/2"
 Accuracy: \pm 3 % of full scale

Rotating Vane - Low Volume

Stainless steel

Model: DTK



Water: 0.05 - 0.6 l/min ... 1 - 12 l/min
 t_{max} 140 °C; p_{max} 30 bar
 Connection: G 1/4, 1/4" NPT female thread
 Accuracy: \pm 2 % of full scale

Rotating Vane - Low Volume - Pulse Output

Trogamide, Polysulfone, brass, Polypropylene, stainless steel

Model: DF-H



Water: 0.08 - 0.5 l/min ... 40 - 160 l/min
 t_{max} 80 °C; p_{max} 100 bar
 Connection:
 G 1/4...1 1/2, 1/4...1 1/2" NPT female thread, flange DN 15...50, ANSI 1/2"...2"
 Accuracy: \pm 2.5 % of full scale

Rotating Vane - Low Volume - Analogue Output

Trogamide, Polysulfone, brass, Polypropylene, stainless steel

Model: DF-MA



Water: 0.08 - 0.5 l/min ... 40 - 160 l/min
 t_{max} 80 °C; p_{max} 100 bar
 Connection:
 G 1/4...1 1/2, 1/4...1 1/2" NPT female thread, flange DN 15...50, ANSI 1/2"...2"
 Accuracy: \pm 2.5 % of full scale

Rotating Vane Switch - Low Volume

Trogamide, Polysulfone, brass, Polypropylene, stainless steel

Model: DF-WM



Water: 0.08 - 0.5 l/min ... 40 - 160 l/min
 t_{max} 80 °C; p_{max} 100 bar
 Connection:
 G 1/4...1 1/2, 1/4...1 1/2" NPT female thread, flange DN 15...50, ANSI 1/2"...2"
 Accuracy: \pm 2.5 % of full scale

Rotating Vane - Low Volume - Digital Display

Trogamide, Polysulfone, brass, Polypropylene, stainless steel

Model: DF-K



Water: 0.08 - 0.5 l/min ... 40 - 160 l/min
 t_{max} 80 °C; p_{max} 100 bar
 Connection:
 G 1/4...1 1/2, 1/4...1 1/2" NPT female thread, flange DN 15...50, ANSI 1/2"...2"
 Accuracy: \pm 2.5 % of full scale

Rotating Vane - Low Volume - Counter

Trogamide, Polysulfone, Polypropylene, brass, stainless steel

Model: DF-Z



Water: 0.08 - 0.5 l/min ... 40 - 160 l/min
 t_{max} 80 °C; p_{max} 100 bar
 Connection:
 G 1/4...1 1/2, 1/4...1 1/2" NPT female thread, flange DN 15...50, ANSI 1/2"...2"
 Accuracy: \pm 2.5 % of full scale

Rotating Vane - Low Volume - Dosing Electronic

Trogamide, Polysulfone, Polypropylene, brass, stainless steel

Model: DF-D



Water: 0.08 - 0.5 l/min ... 40 - 160 l/min
 t_{max} 80 °C; p_{max} 100 bar
 Connection:
 G 1/4...1 1/2, 1/4...1 1/2" NPT female thread, flange DN 15...50, ANSI 1/2"...2"
 Accuracy: \pm 2.5 % of full scale



Rotating Vane - Pulse Output
Brass

Model: DFT-11



Water: 0.2 - 2 l/min ... 3 - 60 l/min
t_{max} 80 °C; p_{max} 16 bar
Connection:
G 1/4...3/4, 1/4...3/4" NPT female thread
Accuracy: ± 2.5 % of full scale

Rotating Vane - Pulse Output
PTFE

Model: DFT-13



Water: 0.2 - 2 l/min ... 3 - 60 l/min
t_{max} 80 °C; p_{max} 16 bar
Connection:
G 1/4...3/4, 1/4...3/4" NPT female thread
Accuracy: ± 2.5 % of full scale

Rotating Vane - Digital Display
PTFE, brass

Model: DFT-13...K



Water: 0.2 - 2 l/min ... 3 - 60 l/min
t_{max} 80 °C; p_{max} 16 bar
Connection:
G 1/4...3/4, 1/4...3/4" NPT female thread
Accuracy: ± 2.5 % of full scale

Rotating Vane - Pulse - Analogue Output

POM, PVDF, brass, stainless steel
Model: DRH-...F, DRH-...L



Water: 0.2 - 0.8 l/min ... 2.5 - 50 l/min
t_{max} 80 °C; p_{max} 100 bar
Connection:
G 3/8, G 1, 3/8" NPT, 1" NPT female thread
Accuracy: ± 2.5 % of full scale

Rotating Vane - Analogue Output

POM, PVDF, brass, stainless steel

Model: DRH with AUF



Water: 0.2 - 0.8 l/min ... 2.5 - 50 l/min
t_{max} 80 °C; p_{max} 100 bar
Connection:
G 3/8, G 1, 3/8" NPT, 1" NPT female thread
Accuracy: ± 2.5 % of full scale

Rotating Vane - Pointer Indicator

POM, PVDF, brass, stainless steel

Model: DRH-...Z3



Water: 0.2 - 0.8 l/min ... 2.5 - 50 l/min
t_{max} 80 °C; p_{max} 100 bar
Connection:
G 3/8, G 1, 3/8" NPT, 1" NPT female thread
Accuracy: ± 2.5 % of full scale

Rotating Vane - Compact Electronics

POM, PVDF, brass, stainless steel

Model: DRH-...C3



Water: 0.2 - 0.8 l/min ... 2.5 - 50 l/min
t_{max} 80 °C; p_{max} 100 bar
Connection:
G 3/8, G 1, 3/8" NPT, 1" NPT female thread
Accuracy: ± 2.5 % of full scale

Rotating Vane - Digital Display / Counter / Dosing Electronic

POM, PVDF, brass, stainless steel

Model: DRH with ADI-1/ZED



Water: 0.2 - 0.8 l/min ... 2.5 - 50 l/min
t_{max} 80 °C; p_{max} 100 bar
Connection:
G 3/8, G 1, 3/8" NPT, 1" NPT female thread
Accuracy: ± 2.5 % of full scale

Rotating Vane - Pulse/Analogue Output

Polypropylene, aluminium-bronze, stainless steel

Model: DRG-...F, DRG...L



Water: 0.5 - 12 l/min ... 10 - 140 l/min
t_{max} 80 °C; p_{max} 40 bar
Connection:
G 1/2...1, 1/2...1" NPT female thread
Accuracy: ± 3 % of full scale

Rotating Vane - Analogue Output

Polypropylene, aluminium-bronze, stainless steel

Model: DRG with AUF



Water: 0.5 - 12 l/min ... 10 - 140 l/min
t_{max} 80 °C; p_{max} 40 bar
Connection:
G 1/2...1, 1/2...1" NPT female thread
Accuracy: ± 3 % of full scale

Rotating Vane - Pointer Indicator

Polypropylene, aluminium-bronze, stainless steel

Model: DRG-...Z3



Water: 0.5 - 12 l/min ... 10 - 140 l/min
t_{max} 80 °C; p_{max} 40 bar
Connection:
G 1/2...1, 1/2...1" NPT female thread
Accuracy: ± 3 % of full scale

Rotating Vane - Compact Electronics

Polypropylene, aluminium-bronze, stainless steel

Model: DRG-...C3



Water: 0.5 - 12 l/min ... 10 - 140 l/min
t_{max} 80 °C; p_{max} 40 bar
Connection:
G 1/2...1, 1/2...1" NPT female thread
Accuracy: ± 3 % of full scale





Flowmeters/-switches

Rotating Vane - Digital Display/Counter/Dosing Electronic

Polypropylene, aluminium-bronze, stainless steel

Model: DRG with ADI-1/ZED



Water: 0.5 - 12 l/min ... 10 - 140 l/min
 t_{max} 80 °C; p_{max} 40 bar
 Connection:
 G 1/8...1, 1/8...1" NPT female thread
 Accuracy: ± 3 % of full scale

Rotating Vane - Insertion Version

Stainless steel

Model: DOR



Water: 0.3 - 10 m/s
 t_{max} 150 °C; p_{max} 80 bar
 Connection: G 1 1/2, G 2, 1 1/2" NPT, 2" NPT
 male thread for tubes \varnothing 40...2500 mm
 Accuracy: ± 1.5 % (linearity)

Dual-Ring Piston - Pendulum - Low Volume

Stainless steel

Model: LFM



Water: 0.005 - 0.25 l/min
 t_{max} 70 °C; p_{max} 100 bar
 Connection: G 1/8, Swagelok 6 mm
 Accuracy: ± 2.5 % of reading

Ring Piston Counter - Pulse Output

Brass

Model: DRZ-...F



Viscosity range: 5 - 100 mm²/s
 Oil: 6 - 420 l/h
 t_{max} 80 °C; p_{max} 40 bar
 Connection:
 G 1/8, G 1/4, 1/8" NPT, 1/4" NPT female thread
 Accuracy: ± 1 % of reading

Ring Piston Counter - Analogue Output

Brass

Model: DRZ with AUF



Viscosity range: 5 - 100 mm²/s
 Oil: 6 - 420 l/h
 t_{max} 80 °C; p_{max} 40 bar
 Connection:
 G 1/8, G 1/4, 1/8" NPT, 1/4" NPT female thread
 Accuracy: ± 1 % of reading

Ring Piston Counter - Compact Electronics

Brass

Model: DRZ-...C3



Viscosity range: 5 - 100 mm²/s
 Oil: 6 - 420 l/h
 t_{max} 80 °C; p_{max} 40 bar
 Connection:
 G 1/8, G 1/4, 1/8" NPT, 1/4" NPT female thread
 Accuracy: ± 1 % of reading

Oval Gear - Pulse Output

POM, aluminium

Model: OVZ-...I4



Viscosity range: 10 - 800 mm²/s
 Oil: 0.3 - 8 l/min ... 1.6 - 40 l/min
 t_{max} 80 °C; p_{max} 40 bar
 Connection:
 G 1/4...3/4, 1/4...3/4" NPT female thread
 Accuracy: ± 2.5 % of full scale

Oval Gear - Analogue Output

POM, aluminium

Model: OVZ-...L4 with AUF



Viscosity range: 10 - 800 mm²/s
 Oil: 0.3 - 8 l/min ... 1.6 - 40 l/min
 t_{max} 80 °C; p_{max} 40 bar
 Connection:
 G 1/4...3/4, 1/4...3/4" NPT female thread
 Accuracy: ± 2.5 % of full scale

Oval Gear - Pointer Indicator

POM, aluminium

Model: OVZ-...Z3



Viscosity range: 10 - 800 mm²/s
 Oil: 0.3 - 8 l/min ... 1.6 - 40 l/min
 t_{max} 80 °C; p_{max} 40 bar
 Connection:
 G 1/4...3/4, 1/4...3/4" NPT female thread
 Accuracy: ± 2.5 % of full scale

Oval Gear - Compact Electronics

POM, aluminium

Model: OVZ-...C3



Viscosity range: 10 - 800 mm²/s
 Oil: 0.3 - 8 l/min ... 1.6 - 40 l/min
 t_{max} 80 °C; p_{max} 40 bar
 Connection:
 G 1/4...3/4, 1/4...3/4" NPT female thread
 Accuracy: ± 2.5 % of full scale

Oval Gear - Dosing Electronics

POM, aluminium

Model: OVZ with ZED



Viscosity range: 10 - 800 mm²/s
 Oil: 0.3 - 8 l/min ... 1.6 - 40 l/min
 t_{max} 80 °C; p_{max} 40 bar
 Connection:
 G 1/4...3/4, 1/4...3/4" NPT female thread
 Accuracy: ± 2.5 % of full scale

Oval Gear - Pulse Output

Aluminium, stainless steel

Model: DON



Viscosity range: 0 - 1 000 000 mPas
 Oil: 0.5 - 36 l/h ... 150 - 2500 l/min
 t_{max} 120 °C; p_{max} 400 bar
 Connection: G 1/2...4 female thread,
 flange DN 25...100, ANSI 1"...4"
 Accuracy: $\pm 0.2 - 1$ % of reading



Flowmeters/-switches

Oval Gear - Counter - Pulse Output
Aluminium, stainless steel
Model: DON-...LCD



Viscosity range: 0 - 1 000 000 mPas
Oil: 0.5 - 36 l/h ... 150 - 2500 l/min
t_{max} 120 °C; p_{max} 400 bar
Connection: G ½...4 female thread,
flange DN 25...100, ANSI 1"..."4"
Accuracy: ± 0.2 - 1 % of reading

Oval Gear - Counter - Mechanical
Aluminium, stainless steel
Model: DON-...mech



Viscosity range: 0 - 1 000 000 mPas
Oil: 0.5 - 36 l/h ... 150 - 2500 l/min
t_{max} 120 °C; p_{max} 400 bar
Connection: G ½...4 female thread,
flange DN 25...100, ANSI 1"..."4"
Accuracy: ± 0.2 - 1 % of reading

Oval Gear - Pulse Output
PPS
Model: DOC



Viscosity range: 0 - 1 000 mPas
Oil: 0.5 - 100 l/h ... 3 - 80 l/min
t_{max} 80 °C; p_{max} 10 bar
Connection: G ¼ ... G 1, ¼" ... 1" NPT
Accuracy: ± 0.5 % of reading

Screw Spindle - Meter
Cast iron, stainless steel
Model: OMG



Viscosity range: 1 - 5000 mm²/s
Oil: 0.1 - 10 l/min ... 50 - 5000 l/min
t_{max} 200 °C; p_{max} 250 bar
Connection:
G ½...6 female thread, flange DN 15...150
Accuracy: ± 0.3 % of reading

Screw Spindle - Digital Display / Counter / Dosing Electronic
Cast iron, stainless steel
Model: OMG with ADI-1/ZED



Viscosity range: 1 - 5000 mm²/s
Oil: 0.1 - 10 l/min ... 50 - 5000 l/min
t_{max} 200 °C; p_{max} 250 bar
Connection:
G ½...6 female thread, flange DN 15...150
Accuracy: ± 0.3 % of reading

Screw Spindle - Meter
Aluminium
Model: OME



Viscosity range: 1 - 5000 mm²/s
Oil: 0.1 - 15 l/min ... 3.5 - 350 l/min
t_{max} 125 °C; p_{max} 40 bar
Connection:
G ½...1 ½ female thread, flange DN 15...40
Accuracy: ± 0.3 % of reading

Screw Spindle - Digital Display / Counter / Dosing Electronic
Aluminium
Model: OME with ADI-1/ZED



Viscosity range: 1 - 5000 mm²/s
Oil: 0.1 - 15 l/min ... 3.5 - 350 l/min
t_{max} 125 °C; p_{max} 40 bar
Connection:
G ½...1 ½ female thread, flange DN 15...40
Accuracy: ± 0.3 % of reading

Gear Wheel - Meter
Cast iron, stainless steel
Model: DZR



Viscosity range: 20 - 5000 mm²/s
Oil: 0.008 - 2 l/min ... 3 - 700 l/min
t_{max} 150 °C; p_{max} 400 bar
Connection: G ¾...1 female thread
Accuracy: ± 0.3 - 1 % of reading

Gear Wheel - Digital Display / Counter / Dosing Electronic
Cast iron, stainless steel
Model: DZR with ADI-1/ZED



Viscosity range: 20 - 5000 mm²/s
Oil: 0.008 - 2 l/min ... 3 - 700 l/min
t_{max} 150 °C; p_{max} 400 bar
Connection: G ¾...1 female thread
Accuracy: ± 0.3 - 1 % of reading

Gear Wheel - Meter
Aluminium
Model: KZA



Viscosity range: 20 - 4000 mm²/s
Oil: 0.02 - 4 l/min ... 1 - 200 l/min
t_{max} 80 °C; p_{max} 160 bar
Connection: G ¼...1 female thread
Accuracy: ± 0.3 - 3 % of reading

Gear Wheel - Digital Display / Counter / Dosing Electronic
Aluminium
Model: KZA with ADI-1/ZED



Viscosity range: 20 - 4000 mm²/s
Oil: 0.02 - 4 l/min ... 1 - 200 l/min
t_{max} 80 °C; p_{max} 160 bar
Connection: G ¼...1 female thread
Accuracy: ± 0.3 - 3 % of reading

Calorimetric Indicator/Switch
Stainless steel
Model: KAL-D



Water: 0.04 - 2 m/s
t_{max} 80 °C; p_{max} 40 bar
Connection:
G ¼, G ½, ¼" NPT, ½" NPT, M12





Flowmeters/-switches

Calorimetric Indicator/Switch

Stainless steel

Model: KAL-K



Water: 0.04 - 2 m/s
 t_{max} 120 °C; p_{max} 100 bar
 Connection:
 G ¼...1½, ¼...¾" NPT, M12, Tri-Clamp®

Calorimetric Meter/Switch

Stainless steel

Model: KAL-A(K)



Water: 0.04 - 2 m/s
 t_{max} 120 °C; p_{max} 100 bar
 Connection:
 G ¼...1½, ¼...¾" NPT, M12, Tri-Clamp®
 Accuracy: ± 10 % of full scale

Calorimetric Indicator/Switch

Brass, stainless steel

Model: KAL, KAL-E



Water: 0.04 - 2 m/s
 t_{max} 120 °C; p_{max} 100 bar
 Connection:
 G ¼...1½, ¼...¾" NPT, M12

Calorimetric Flowmeter/Switch

Stainless steel

Model: DVK



Air: 1 - 10 NI/min ... 600 - 12000 NI/h
 t_{max} 50 °C; p_{max} 15 bar
 Connection: G ¼...2
 Accuracy: ± 5 % of full scale

Calorimetric Indicator/Switch

Brass

Model: KAL-L



Air: 1 - 20 m/s
 t_{max} 120 °C; p_{max} 8 bar
 Connection:
 G ½, Rp ½, M18, flange, smooth shaft
 Accuracy: ± 10 % of reading

Air velocity sensor

Polycarbonate

Model: KAH



Air: 0 ... 10/15/20 m/s
 Output signal: 0 ... 10 V_{DC} or 4 ... 20 mA
 Supply voltage: 24 V_{AC/DC}
 Connection: Mounting adapter
 Accuracy: ±(0.2 m/s + 3 % of reading)

Mass - Flowmeter - Thermal

Aluminium, stainless steel

Model: DMW-A/B



Air: 5 - 100 Nml/min ... 300 - 6000 NI/min
 t_{max} 50 °C; p_{max} 10 bar
 Connection: G ¼...1 female thread
 Accuracy: ± 3 % of full scale

Mass - Flowmeter/Controller - Thermal

Aluminium, stainless steel

Model: DMW-C/D



Air: 5 - 100 Nml/min ... 50 - 1000 NI/min
 t_{max} 50 °C; p_{max} 10 bar
 Connection: G ¼...½ female thread
 Accuracy: ± 3 % of full scale

Mass - Flowmeter - Thermal

Nylon, stainless steel

Model: MAS



Air: 0 - 10 Nml/min ... 0 - 500 NI/min
 t_{max} 50 °C; p_{max} 35 bar
 Connection:
 ¼" NPT female thread, Swagelok
 Accuracy: ± 1.5 % of full scale

Mass - Meter/Controller - Thermal

Nylon, stainless steel

Model: MFC



Air: 0 - 10 Nml/min ... 0 - 500 NI/min
 t_{max} 50 °C; p_{max} 35 bar
 Connection:
 ¼" NPT female thread, Swagelok
 Accuracy: ± 1.5 % of full scale

Mass - Meter/Controller - Thermal

Stainless steel

Model: DMS



Air: 0.1 - 3.7 Nml/min ... 0 - 185 NI/min
 t_{max} 50 °C; p_{max} 35 bar
 Connection: ¼...½" NPT female thread, clamp connection
 Accuracy: ± 1 % of full scale

Mass - Flowmeter - Thermal

Stainless steel

Model: KMT-1/-2/-3

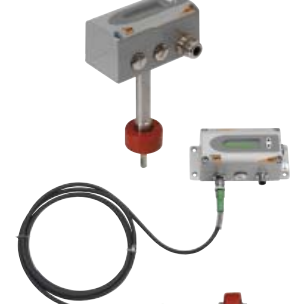

Air: 0.5 - 200 Nm/s
 t_{max} 80 °C; p_{max} 16 bar
 Connection: R ½...2 ball valve
 Accuracy:
 ±1.5% of reading ± 0.5% of full scale



Flowmeters/-switches

Mass - Flowmeter - Thermal
Stainless steel

Model: KMT-4

Installation under Pressure



Air: 0.2 - 200 Nm/s
t_{max} 80 °C; p_{max} 16 bar
Connection: R 1/2" male thread for insertion (DN65...DN700)
Accuracy: ± 1.5% of reading ± 0.8% of full scale

Mass - Flowmeter - Thermal
Stainless steel

Model: KES-1/3/4



Air: 0 - 4.7 m/s ... 0 - 94 m/s
t_{max} 175 °C; p_{max} 16 bar
Connection: 1/4...8" NPT, compression fitting with 1/2" NPT, 1" NPT
Accuracy: ±1.0% of full scale ± 0.5% of reading

Coriolis Mass
Stainless steel

Model: TME/UMC-3



Water: 0 - 60 kg/h ... 0 - 60 000 kg/h
t_{max} 180 °C; p_{max} PN 40
Connection: flange DN 10...80, ANSI 1/2"...3"
Accuracy: ± 0.15% of reading

Coriolis Mass
Stainless steel, Hastelloy

Model: TMU/UMC-3



Water: 0 - 60 kg/h ... 0 - 2 200 000 kg/h
t_{max} 260 °C;
p_{max} PN 40 (bis 750 bar on request)
Connection: flange DN 10...300, ANSI 1/2"...12"
Accuracy: ± 0.1% of reading

Coriolis Mass with Heating
Stainless steel, Hastelloy

Model: TMU-...AC

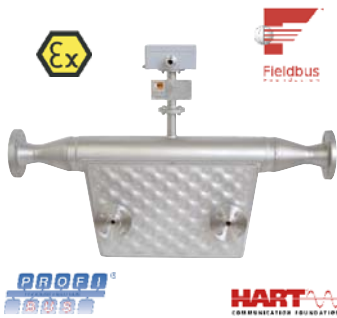

Water: 0 - 60 kg/h ... 0 - 1 900 000 kg/h
t_{max} 260 °C; p_{max} PN 40
Connection: flange DN 10...300, ANSI 1/2"...12"
Accuracy: ± 0.1% of reading

Coriolis Mass
Stainless steel, Hastelloy, tantalum

Model: TM/UMC-3



Water: 0 - 0.8 kg/h ... 0 - 65 000 kg/h
t_{max} 260 °C; p_{max} up to 900 bar
Connection: 1/4...1/2" NPT, flange DN 10...100, ANSI 1/2"...4"
Accuracy: ± 0.1% of reading

Coriolis Mass
Stainless steel, Hastelloy, tantalum

Model: TMR/UMC-3



Viscosity range: 0.3 - 50 000 mPas
Water: 0 - 120 kg/h ... 0 - 120 000 kg/h
t_{max} 260 °C; p_{max} PN 40
Connection: flange DN 20...100, ANSI 1/4"...4"
Accuracy: ± 0.1 - 0.15% of reading

Coriolis Mass
Stainless steel

Model: TME/UMC-4



Water: 0 - 60 kg/h ... 0 - 60 000 kg/h
t_{max} 180 °C; p_{max} PN 40
Connection: flange DN 10...80, ANSI 1/2"...3"
Accuracy: ± 0.15% of reading

Coriolis Mass
Stainless steel, Hastelloy

Model: TMU/UMC-4



Water: 0 - 60 kg/h ... 0 - 2 200 000 kg/h
t_{max} 260 °C;
p_{max} PN 40 (up to 750 bar on request)
Connection: flange DN 10...300, ANSI 1/2"...12"
Accuracy: ± 0.1% of reading

Orifice Plate - Differential Pressure
Steel, stainless steel, Hastelloy C, titanium, Monel, tantalum

Model: KPL



Ranges: for liquids, gases, steam
Connection: DN 50 ... 600, ANSI 2" ... 24"
t_{max} 500 °C; p_{max} PN 420

Orifice Plate - Differential Pressure
Steel, stainless steel, Hastelloy C, titanium, Monel, tantalum

Model: KPL-B/-F



Ranges: for liquids, gases, steam
Connection: DN 50 ... 600, ANSI 2" ... 24"
t_{max} 500 °C; p_{max} PN 420

Pitot Tube - Differential Pressure
Stainless steel

Model: ANU



Connection: G 1 ... 2, 1" ... 2" NPT, DN 25...100, ANSI 1"...4"
Probe length: 50 mm...15 000 mm (2"...600")
t_{max} 900 °C; p_{max} PN 250





Flowmeters/-switches

Nozzle - Differential Pressure
Steel, stainless steel

Model: DUS



Nominal diameter: DN 50...600 (2" ... 24")
 t_{max} 560 °C; p_{max} 420 bar

Venturi tube - Differential Pressure
Steel, stainless steel

Model: DVT



Nominal diameter:
DN 50...1200 (2" ... 48")
 t_{max} 560 °C; p_{max} 420 bar

Venturi Nozzle - Differential Pressure
Aluminium-bronze, stainless steel

Model: RCD-...Z



Water: 0.5 - 3.3 l/min ... 300 - 2350 l/min
Air:
0.5 - 5.35 Nm³/h ... 300 - 2750 Nm³/h
 t_{max} 100 °C; p_{max} PN 40
Connection:
G 1/2...3, 1/2...3" NPT female thread
Accuracy: \pm 3 % of full scale

Venturi Nozzle - Differential Pressure
Aluminium-bronze, stainless steel

Model: RCD-...C3



Water: 0.5 - 3.3 l/min ... 300 - 2350 l/min
Air:
0.5 - 5.35 Nm³/h ... 300 - 2750 Nm³/h
 t_{max} 100 °C; p_{max} PN 40
Connection:
G 1/2...3, 1/2...3" NPT female thread
Accuracy: \pm 3 % of full scale

Venturi Nozzle - Differential Pressure
Aluminium-bronze, stainless steel

Model: RCD-...K



Water: 0.5 - 3.3 l/min ... 300 - 2350 l/min
Air:
0.5 - 5.35 Nm³/h ... 300 - 2750 Nm³/h
 t_{max} 100 °C; p_{max} PN 40
Connection:
G 1/2...3, 1/2...3" NPT female thread
Accuracy: \pm 3 % of full scale

Electromagnetic - Analogue Output
PPS/Stainless steel, PVDF/Hastelloy

Model: MIK-...L4 with AUF

High Quality - Low Cost



Water:
10 - 500 ml/min ... 37 - 700 l/min
 t_{max} 80 °C; p_{max} 10 bar
Connection: G 1/2...2 3/4 male thread
Accuracy: \pm 2 % of full scale

Electromagnetic - Pulse Output
PPS/Stainless steel, PVDF/Hastelloy

Model: MIK-...F3

High Quality - Low Cost



Water:
10 - 500 ml/min ... 37 - 700 l/min
 t_{max} 80 °C; p_{max} 10 bar
Connection: G 1/2...2 3/4 male thread
Accuracy: \pm 2 % of full scale

Electromagnetic - Compact Electronics
PPS/Stainless steel, PVDF/Hastelloy

Model: MIK-...C3

High Quality - Low Cost



Water:
10 - 500 ml/min ... 37 - 700 l/min
 t_{max} 80 °C; p_{max} 10 bar
Connection: G 1/2...2 3/4 male thread
Accuracy: \pm 2 % of full scale

Electromagnetic - Counter
PPS/Stainless steel, PVDF/Hastelloy

Model: MIK-...E

High Quality - Low Cost



Water:
10 - 500 ml/min ... 37 - 700 l/min
 t_{max} 80 °C; p_{max} 10 bar
Connection: G 1/2...2 3/4 male thread
Accuracy: \pm 2 % of full scale

Electromagnetic - Dosing Electronics
PPS/Stainless steel, PVDF/Hastelloy

Model: MIK-...G

High Quality - Low Cost



Water:
10 - 500 ml/min ... 37 - 700 l/min
 t_{max} 80 °C; p_{max} 10 bar
Connection: G 1/2...2 3/4 male thread
Accuracy: \pm 2 % of full scale

Electromagnetic - Insertion
Stainless steel/PTFE- or PFA-lining

Model: PIT



Water: 0.5 - 5 m/s or 1 - 10 m/s
 t_{max} 150 °C; p_{max} PN 40
Connection: flange DN 40...80,
ANSI 2" ... 3", for pipelines DN 125 ... 2000
Accuracy:
 \pm 1.5 % of reading \pm 0.5 % of full scale

Electromagnetic - Insertion with Installation/Extracting Device
Stainless steel/PTFE- or PFA-lining

Model: PIT-U



Water: 0.5 - 5 m/s or 1 - 10 m/s
 t_{max} 100 °C; p_{max} PN 40
Connection:
flange DN 40...80, ANSI 2" ... 3"
Accuracy:
 \pm 1.5 % of reading \pm 0.5 % of full scale



Flowmeters/-switches

Electromagnetic - Insertion
Stainless steel
Model: PITE

High Quality - Low Cost



Water: 0 - 10 m/s
 t_{max} 100°C; p_{max} PN 16
Connection: weld-on nozzle \varnothing 40 mm,
sensor with union nut M52x2
for pipelines DN 50...400, ANSI 2"...16"
IP 68
Accuracy: \pm 1.5 % of full scale

Electromagnetic Meter
Lining: hard rubber, soft rubber,
PTFE/PFA
Model: DMH



Water: 0 - 10 m/s
 t_{max} 150°C; p_{max} PN 40
Connection:
flange DN 10...1200, ANSI 1/2"...48"
Option: Sensor in stainless steel, wafer
type, sanitary connections
Accuracy: \pm 0.3 % of reading

Electromagnetic Meter
Lining: hard rubber, soft rubber, PTFE
Model: EPX



Water: 0 - 10 m/s
 t_{max} 118°C; p_{max} PN 40
Connection:
flange DN 10...300, ANSI 1/2"...12"
Accuracy: \pm 0.3 % of reading

Vortex - Switch
PPS/Brass, PPS/Stainless steel
Model: DVZ-...S3

High Quality - Low Cost



Water: 0.5 - 4.5 l/min ... 10 - 100 l/min
 t_{max} 80°C; p_{max} 20 bar
Connection: G 1/4 ... 1, 1/4 ... 1" NPT
Accuracy: \pm 2.5 % of full scale

Vortex - Analogue Output
PPS/Brass, PPS/Stainless steel
Model: DVZ-...L/L4 with AUF

High Quality - Low Cost



Water: 0.5 - 4.5 l/min ... 10 - 100 l/min
 t_{max} 80°C; p_{max} 20 bar
Connection: G 1/4 ... 1, 1/4 ... 1" NPT
Accuracy: \pm 2.5 % of full scale

Vortex - Pulse Output
PPS/Brass, PPS/Stainless steel
Model: DVZ-...F3

High Quality - Low Cost



Water: 0.5 - 4.5 l/min ... 10 - 100 l/min
 t_{max} 80°C; p_{max} 20 bar
Connection: G 1/4 ... 1, 1/4 ... 1" NPT
Accuracy: \pm 2.5 % of full scale

Vortex - Compact Electronic
PPS/Brass, PPS/Stainless steel
Model: DVZ-...C3

High Quality - Low Cost



Water: 0.5 - 4.5 l/min ... 10 - 100 l/min
 t_{max} 80°C; p_{max} 20 bar
Connection: G 1/4 ... 1, 1/4 ... 1" NPT
Accuracy: \pm 2.5 % of full scale

Vortex - Counter
PPS/Brass, PPS/Stainless steel
Model: DVZ-...E

High Quality - Low Cost



Water: 0.5 - 4.5 l/min ... 10 - 100 l/min
 t_{max} 80°C; p_{max} 20 bar
Connection: G 1/4 ... 1, 1/4 ... 1" NPT
Accuracy: \pm 2.5 % of full scale

Vortex - Dosing Electronic
PPS/Brass, PPS/Stainless steel
Model: DVZ-...G

High Quality - Low Cost



Water: 0.5 - 4.5 l/min ... 10 - 100 l/min
 t_{max} 80°C; p_{max} 20 bar
Connection: G 1/4 ... 1, 1/4 ... 1" NPT
Accuracy: \pm 2.5 % of full scale

Vortex - Meter
Stainless steel
Model: DVH



Water: 0,2 - 5 ... 32 - 970 m³/h
Air: 3 - 28 Nm³/h ... 3057 - 280187 Nm³/h
Temperature: -200 ... +400 °C
 p_{max} PN 100
Connection: DN 15...200, ANSI 1/2"...8"
Option: integrated temperature and
pressure sensor, wafer type
Accuracy: \pm 0.7 % of reading (water)
 \pm 1 % of reading (gas/steam)

Vortex - Meter - Insertion Version
Stainless steel
Model: DVE

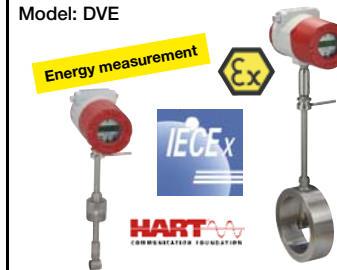

Water: 5.2 - 157 ... 284 - 8537 m³/h
Air:
89 - 1463 Nm³ ... 26915 - 2467081 Nm³/h
Temperature: -200 ... +400 °C
 p_{max} 100 bar
Connection: 2" NPT, DN 50, ANSI 2"
mountable in NW80 ... NW600
Option: integrated temperature and
pressure sensor, Installation/removal device
Accuracy: \pm 1.2 % of reading (water)
 \pm 1.5 % of reading (gas/steam)

Oscillation - Meter/Switch
Stainless steel
Model: DOG-4*



Air: 0.2 - 20 Nm³/h ... 60 - 6000 m³/h
Pressure Drop: max. 50 mbar
 t_{max} 120 °C (for EX 60 °C); p_{max} PN 40
Connection:
Flange DN 25...200, ANSI 1"...8"
Accuracy: \pm 1.5 % of reading

* Sponsored by the Federal Ministry of Economics and Technology on the basis of a resolution of the German Bundestag.





Flowmeters/ Switches

Oscillation - Meter/Switch

Stainless steel

Model: DOG-5

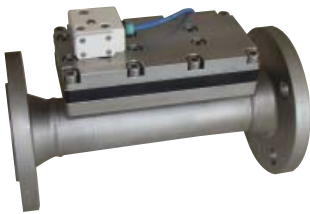

Water:
0.075 - 3.75 m³/h ... 19,6 - 980 m³/h
t_{max} 120 °C; p_{max} PN 40
Connection:
Flange DN 25 ... 200, ANSI 1" ... 8"
Accuracy: ± 0.5 % of reading

Oscillation - Meter/Switch

Transducer/Transmitter

Model: DOG-4.. Electronic options



Input: frequency
Analogue output
Pulse output, counter, flow computer

Ultrasonic - Switch

Brass, stainless steel

Model: DUK-...S3



Water:
0.08 - 20 l/min ... 2.5 - 630 l/min
t_{max} 120 °C; p_{max} 16 bar
Connection: G ½...3 female thread
Accuracy: ± 1.5 % of full scale

Ultrasonic - Analogue Output

Brass, stainless steel

Model: DUK-...L4 with AUf



Water:
0.08 - 20 l/min ... 2.5 - 630 l/min
t_{max} 120 °C; p_{max} 16 bar
Connection: G ½...3 female thread
Accuracy: ± 1.5 % of full scale

Ultrasonic - Pulse Output

Brass, stainless steel

Model: DUK-...F3

High Quality - Low Cost



Water:
0.08 - 20 l/min ... 2.5 - 630 l/min
t_{max} 120 °C; p_{max} 16 bar
Connection: G ½...3 female thread
Accuracy: ± 1.5 % of full scale

Ultrasonic - Compact Electronics

Brass, stainless steel

Model: DUK-...C3

High Quality - Low Cost



Water:
0.08 - 20 l/min ... 2.5 - 630 l/min
t_{max} 120 °C; p_{max} 16 bar
Connection: G ½...3 female thread
Accuracy: ± 1.5 % of full scale

Ultrasonic - Counter/Dosing

Brass, stainless steel

Model: DUK-...E, G

High Quality - Low Cost



Water:
0.08 - 20 l/min ... 2.5 - 630 l/min
t_{max} 120 °C; p_{max} 16 bar
Connection: G ½...3 female thread
Accuracy: ± 1.5 % of full scale

Ultrasonic - Digital Display

Brass, stainless steel

Model: DUK-...K

High Quality - Low Cost



Water:
0.08 - 20 l/min ... 2.5 - 630 l/min
t_{max} 120 °C; p_{max} 16 bar
Connection: G ½...3 female thread
Accuracy: ± 1.5 % of full scale

Flow Regulators

Brass, stainless steel

Model: REG

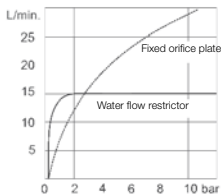

Viscosity range: 1 - 30 mm²/s
Water: 0.5 - 40 l/min
t_{max} 300 °C; p_{max} 200 bar
Connection: G ½, G ¾, ¾" NPT

Flow Regulators - Multiple Element

Brass, stainless steel

Model: REG-8



Viscosity range: 1 - 30 mm²/s
Water: 1 - 280 l/min
t_{max} 300 °C; p_{max} 200 bar
Connection: flange DN 20...50

Flow Regulators - Multiple Element

Brass, stainless steel

Model: REG-9



Viscosity range: 1 - 30 mm²/s
Water: 1 - 280 l/min
t_{max} 300 °C; p_{max} 200 bar
Connection: G 1 ½...G 2 ½

Flow Indicator with Rotor

Brass, stainless steel

Model: DAA, DAH



Wasser: 0.4 - 4 l/min ... 8 - 100 l/min
t_{max} 100 °C; p_{max} 16 bar
Connection:
G ¼...1 ½, ¼...1 ½" NPT female thread



Flow Indicator with Rotor

Grey cast iron, cast steel, stainless steel

Model: DAR-1/-2



t_{max} 260 °C; p_{max} 40 bar
Connection: G 1/4...2, 1/4...2" NPT female thread, flange DN 15...200, ANSI 1/2"...8"

Flow Indicator with Rotating Vane

Brass, stainless steel

Model: DAF-1



Water: 0.03 - 0.1 l/min ... 5 - 150 l/min
 t_{max} 110 °C; p_{max} 16 bar
Connection: G 1/8...1 1/2, 1/8...1 1/2" NPT female thread

Flow Indicator with Rotor

Brass, stainless steel

Model: DAF-2



Water: 0.03 - 0.1 l/min ... 5 - 150 l/min
 t_{max} 110 °C; p_{max} 16 bar
Connection: flange DN 15...50, ANSI 1/2"...2"

Flow Indicator with Rotor

Brass

Model: DKF



Water: 0.14 - 2 l/min ... 1.8 - 83 l/min
 t_{max} 120 °C; p_{max} 6 bar
Connection: G 1/8...1, 1/8...1" NPT female thread

Flow Indicator with Rotor

Brass, stainless steel, POM

Model: DIH

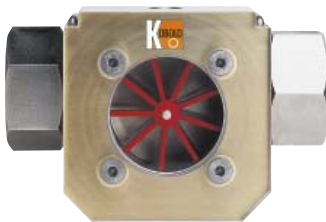

Water: 0.2 - 0.5 l/min ... 1 - 50 l/min
 t_{max} 80 °C; p_{max} 16 bar
Connection: G 3/8, G 1 female thread, 3/8" NPT, 1" NPT

Flow Indicator with Rotor

PP, aluminium-bronze, stainless steel

Model: DIG



Water: 0.5 - 12 l/min ... 3 - 80 l/min
 t_{max} 80 °C; p_{max} 16 bar
Connection: G 1/8...1, 1/8...1" NPT female thread

Flow Indicator with Flap

Grey cast iron, cast steel, stainless steel

Model: DAK-1/-2



t_{max} 280 °C; p_{max} 40 bar
Connection: G 1/4...2, 1/4...2" NPT female thread, flange DN 15...200, ANSI 1/2"...8"

Flow Indicator with Flap

Red cast iron

Model: DAZ

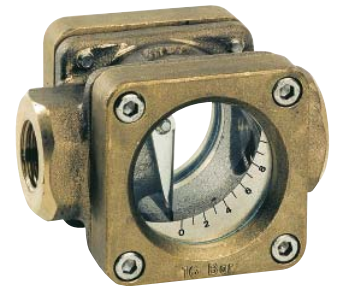

Water: 2.1 - 17 l/min ... 2.1 - 24 l/min
 t_{max} 200 °C; p_{max} 16 bar
Connection: G 1/2...1 female thread

Flow Indicator with Ball

Bronze

Model: DAB



t_{max} 100 °C; p_{max} 6 bar
Connection: G 3/4...3 female thread

Flow Indicator with Ball

Brass, stainless steel

Model: DKB



Water:
0.05 - 15 l/min ... 0.14 - 105 l/min
 t_{max} 200 °C; p_{max} 16 bar
Connection: G 1/8...1 1/2, 1/8...1" NPT female thread

Flow Indicator with Drip Tube

Grey cast iron, cast steel, stainless steel

Model: DAT-1/-2



t_{max} 280 °C; p_{max} 40 bar
Connection: G 1/4...2, 1/4...2" NPT female thread, flange DN 15...200, ANSI 1/2"...8"

Flow Indicator - Sight Glass

Stainless Steel, PVC

Model: UFJ



Connection: G 1/4 ... G 1/2 female thread
 t_{max} 100 °C; p_{max} 6 bar





Pressure Measurement

Bourdon Tube Pressure Gauges

Brass, stainless steel

Model: MAN-R,-Q



Measuring range:
-1 ... 0 bar ... 0 ... +1 000 bar
Housing: Ø 63, 100, 160 mm
Overload protected: 1.15- 1.3 times
Connection:
G ¼, G ½, ¼" NPT, ½" NPT male thread
Accuracy: Cl. 1.0; 1.6

All Stainless Steel Bourdon Tube Pressure Gauges

Stainless steel

Model: MAN-R



Measuring range:
-1 ... 0 bar ... 0 ... +1 000 bar
Housing: Ø 63, 100, 160 mm
Overload protected: 1.15- 1.3 times
Connection:
G ¼, G ½, ¼" NPT, ½" NPT male thread
Accuracy: Cl. 1.0; 1.6

All Stainless Steel Bourdon Tube Pressure Gauges for Exceptional Safety

Stainless steel

Model: MAN-N...S



Measuring range:
-1 ... 0 bar ... 0 ... +1600 bar
Housing: Ø 63, 100, 150 mm
Overload protected: 1.15- 1.5 times
Connection:
G ¼, G ½, ¼" NPT, ½" NPT male thread
Accuracy: Cl. 1.0; 1.6

Bourdon Tube - Refrigeration

Brass, stainless steel

Model: MAN-T



Measuring range:
-1 ... +9 bar ... -1 ... +40 bar
Housing: Ø 63, 80, 100 mm
Overload protected: 1.0 times
Connection: 7/16-20 UNF, G ¼ male
Accuracy: Cl. 1.0; 1.6

Capsule Element Pressure Gauges

Brass, stainless steel

Model: MAN-K



Measuring range:
-10 ... 0 mbar ... 0 ... +600 mbar
Housing: Ø 63, 80, 100, 160 mm
Overload protected: 0.9- 10 times
Connection: G ¼, G ½ male thread
Accuracy: Cl. 1.6

Diaphragm Pressure Gauges

Stainless steel

Model: MAN-P



Measuring range:
-16 ... 0 mbar; 0 ... +40 bar
Housing: Ø 100, 160 mm
Overload protected: 1.15- 1.3 times
Connection: G ½, ½" NPT male thread, flange (nominal size 15 ... 100)
Accuracy: Cl. 1.6

All Stainless Steel Pressure Transducer

Stainless steel

Model: MAN-ZF



Measuring range:
-1 ... 0 bar ... 0 ... +600 bar
Housing: Ø 100 mm
Overload protected: 0.9- 1.0 times
Connection: G ½ male thread
analogue output 4- 20 mA
power supply: 24 V_{DC}
Accuracy: Cl. 1.0

Pressure Gauges Digital with Ceramic Sensor Element, Battery Powered

St. steel/PA glass fibre reinforced

Model: MAN-SD



Measuring range:
-1 ... 0 bar ... 0 ... +1 600 bar
Display: LC-Display
Overload protected: 1.3- 3 times
Connection:
G ¼, G ½, ¼" NPT, ½" NPT male
Accuracy: Cl. 0.5

Pressure Gauges Digital with Ceramic Sensor Element

St. steel/PA glass fibre reinforced

Model: MAN-LD



Measuring range:
-1 ... 0 bar ... 0 ... +1 600 bar
Display: LC-Display
Overload protected: 1.3- 3 times
Connection:
G ¼, G ½, ¼" NPT, ½" NPT male thread
analogue output 4- 20 mA
power supply: 24 V_{DC}
Accuracy: Cl. 0.5

Pressure Gauges with Ceramic/Thin Film Cell

Stainless steel

Model: PDC



Measuring range:
0 ... +2 bar ... 0 ... +700 bar
Display: 2 x 4 ½-digit LCD, illuminated
Overload protected:
2 times - max. 1 000 bar
Connection: G ¼, ¼" NPT male thread
Accuracy: ± 0.5 % of full scale ... ± 1 Digit

Pressure Gauges Digital with Ceramic Sensor Element

St. steel/PA glass fibre reinforced

Model: MAN-SF26



Measuring range:
-1 ... 0 bar ... 0 ... +1 600 bar
Display: 4-digit LED
Overload protected: 2 times
Connection:
G ¼, G ½, ¼" NPT, ½" NPT male thread
Accuracy: Cl. 0.5
Analogue output, 2/4 limit contacts

U-Pipe Pressure Gauges

Glass

Model: PUM



Measuring range:
0 ... ± 25 mbar ... 0 ... ± 150 mbar
Scale division: 2 mm
Hose connection: Ø 7 mm
Accuracy: ± 0.2 mbar



Pressure Measurement

Differential Pressure Gauge Digital with Ceramic Sensor Element

St. steel/PA glass fibre reinforced
Model: MAN-BF26



Measuring range:
-1 ... 0 bar ... 0 ... +1 600 bar
Display: 4-digit LED
Overload protected: 2 times
Connection:
G ¼, G ½, ¼" NPT, ½" NPT male thread
Accuracy: Cl. 0.5

Differential Pressure Gauge Digital with Ceramic Sensor Element

St. steel/PA glass fibre reinforced
Model: MAN-BF20



Measuring range:
-1 ... 0 bar ... 0 ... +1 600 bar
Display: 4-digit LED
Overload protected: 2 times
Connection:
G ¼, G ½, ¼" NPT, ½" NPT male thread
Accuracy: Cl. 0.5

Differential Pressure Gauge Digital with Ceramic Sensor Element

St. steel/PA glass fibre reinforced
Model: MAN-BF28V



Measuring range:
-1 ... 0 bar ... 0 ... +1 600 bar
Display: 4-digit LED
Overload protected: 2 times
Connection:
G ¼, G ½, ¼" NPT, ½" NPT male thread
Accuracy: Cl. 0.5

Differential Pressure Gauge with double diaphragm

Stainless steel
Model: MAN-U



Measuring range:
0 ... +100 mbar ... 0 ... +25 bar
Static pressure on both sides: 200 bar
Housing: Ø 100 mm, 150 mm
Connection:
G ½, ½" NPT male, ¼" NPT female
Accuracy: Cl. 1.6

Differential Pressure Gauge with Bourdon Tube

Brass, stainless steel
Model: MAN-DF, -DG



Measuring range:
0.1 ... +0.3 bar ... 0 ... +600 bar
Overload protected:
1.3 times - (short time)
Connection: G ½ male thread
Accuracy: Cl. 1.6

Differential Pressure Gauge with Bourdon Tube

Aluminium, steel
Model: MAN-DG12R



Measuring range:
0 ... +1 bar ... 0 ... +60 bar
Housing: Ø 160 mm
Overload protected:
1.3 times - (short time)
Connection: G ½ male thread
Accuracy: Cl. 1.6

Differential Pressure Gauge with Diaphragm

Aluminium
Model: MAN-Dx2A



Measuring range:
0 ... +25 mbar ... 0 ... +25 bar
Housing: Ø 100, 160 mm
Connection: G ¼ female thread
Accuracy: Cl. 1.6

Differential Pressure Gauge with Diaphragm

Stainless steel
Model: MAN-DF2G, -DG2G



Measuring range:
0 ... +60 mbar ... 0 ... +40 bar
special versions up to PN 400
Housing: Ø 100, 160 mm
Connection: G ½ female thread
Accuracy: Cl. 1.6

Hand-Held Pressure Measuring Device for Differential Pressure for 2 External Sensors

Model: HND-P215



Measuring range: +2.5 mbar ... +1000 bar
depending on sensor
Option: logger, alarm, control function
Accuracy: ± 0.1 % of full scale

Hand-Held Pressure Measuring Device for Differential Pressure for 2 Integrated Sensors

Model: HND-P126, -P236



Measuring range: -100 ... +2000 mbar
Option: logger, alarm
Accuracy: ± 0.2 % of full scale

Differential Pressure Sensor - Thin Film

Model: PMP



Measuring range: 0 ... +50 mbar
Power supply: 24 V_{AC/DC}, 110 V_{AC}, 230 V_{AC}
Display: 4-digit LED
Connection: hose connection 6 x 8 mm

Differential Pressure Transmitter

St. steel, Monel, tantalum, Hastelloy
Model: PAD

High Quality - Low Cost



Measuring range:
+0.75 mbar ... +413.70 bar
Power supply: 18-45 V_{DC}
Connection: ¼" NPT, ½" NPT
Accuracy: ± 0.075% of measuring span





Pressure Measurement

Differential Pressure Transmitter with Diaphragm Seal

St. steel, Monel, Tantalum, Hastelloy, PTFE
Model: PAD-...N

High Quality - Low Cost



Measuring range:
0 ... +250 mbar ... 0 ... +206.80 bar
 t_{max} 200 °C
Connection: flange-, thread-, clamp on-, and in-line diaphragm seal (nominal size 15 ... 100)
Accuracy: $\pm 0.075\%$ of calibrated span + influence of diaphragm seal

Pressure Transmitter for Harsh Conditions

Brass
Model: PNK

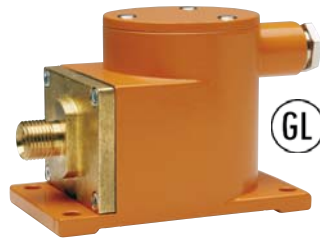

Measuring range:
-1 ... 0 bar ... 0 ... +100 bar
Overload protected: 1.6 times
Connection: M16x1,5 mit sealing cone,
Adapter: R 1/4, R 1/2, 1/2" NPT male thread
accuracy: $\pm 1\%$ of full scale

Test Pressure Gauge with Bourdon Tube

Aluminium, brass, stainless steel
Model: MAN-F



Measuring range:
-0.6 ... 0 bar ... 0 ... +2500 bar
Housing: \varnothing 160, 250 mm
Overload protected: 1.0 times - (calm)
Connection: G 1/2 male thread
Accuracy: Cl. 0.25; 0.6

Pressure Gauge with Membrane Diaphragm Seal

Stainless steel
Model: MAN-RF...D



Measuring range:
-1 ... +3 bar ... 0 ... +40 bar
Housing: \varnothing 100 mm
Overload protected: 1.3 times
Connection: flange \varnothing 85 mm
Accuracy: Cl. 1.6

Diaphragm, Capsule, and Inline Diaphragm Seals for Pressure Gauges

Stainless steel, special material on request
Model: DRM



Measuring range:
0 ... +1 bar ... 0 ... +1600 bar
Filling: glycerine, paraffin- and silicone oil
diverse thread and flange connection,
Tri-Clamp®, DIN 11851, SMS- and
IDF-Norm
Accuracy: Cl. 1.6

Flange Diaphragm Seals

Stainless steel, Monel, Tantalum, Hastelloy, PTFE
Model: DRM



Standard version up to 350 °C/40 bar:
DN 25 ... DN 100, ANSI 1" ... 4"
Special version up to 400 bar:
up to DN 200, ANSI 8"
Flanges according to BS, JIS and GOST
Standard
All possible also with extended diaphragm

All Stainless Steel Bourdon Tube Pressure Gauge with Membrane Diaphragm

Stainless steel
Model: MAN-RD...DRM-600



Measuring range:
0 ... +6 bar ... 0 ... +1600 bar
Housing: \varnothing 63 mm
Connection:
G / NPT-thread; M 20x1.5; M 48x3
Accuracy: Cl. 2.5

Pressure Gauge with Diaphragm Seal DIN 11851 and Cool. Element

Stainless steel
Model: MAN-RF...MZB-711...DRM-602



Measuring range:
0 ... +1 bar ... 0 ... +40 bar
Housing: \varnothing 100 mm
Connection: DIN 11851 DN 20... 100
Accuracy: Cl. 1.6

All Stainless Steel Pressure Gauge with Membrane Diaphragm

Stainless steel
Model: MAN-RF...M1...DRM-628



Measuring range:
0 ... +1 bar ... 0 ... +40 bar
Housing: \varnothing 100, 160 mm
Connection: flange DN 25... 100
Accuracy: Cl. 1.6

All Stainless Steel Pressure Gauge with Membrane Diaphragm

Stainless steel
Model: MAN-RF...M1...DRM-620



Measuring range:
0 ... +1 bar ... 0 ... +40 bar
Housing: \varnothing 100, 160 mm
diverse thread and flange connection,
Tri-Clamp®, DIN 11851, SMS- and
IDF-Norm
Accuracy: Cl. 1.6

All Stainless Steel Pressure Gauge with In-Line Diaphragm

Stainless steel
Model: MAN-RF...DRM-502



Measuring range:
+1.6 ... +40 bar ... +2.5 ... +40 bar
Housing: \varnothing 100, 160 mm
Connection: Tri-Clamp® 1/2" ... 2",
hygienic connection ISO DN 15...50
Accuracy: Cl. 1.6

Contact Pressure Gauge with Membrane Diaphragm Seal DIN 11851

Stainless steel
Model: MAN-RF...M21...DRM-602



Measuring range:
0 ... +1 bar ... 0 ... +40 bar
Housing: \varnothing 100, 160 mm
Connection: DIN 11851 DN 20... 100
Accuracy: Cl. 1.6



Pressure Measurement

Pressure Gauge with Membrane Diaphragm Seal, DIN 11851

Stainless steel

Model: MAN-RF...DRM-603



Measuring range:
0 ... +1 bar ... 0 ... +40 bar
Housing: Ø 100 mm
Connection: DIN 11851 DN 25...100
Accuracy: Cl. 1.6

Pressure Gauge with Diaphragm Seal Clamp Connection

Stainless steel

Model: MAN-RF...DRM-613



Measuring range:
0 ... +2.5 bar ... 0 ... +10 bar
Housing: Ø 100 mm
Connection: Tri-Clamp® 1" ...3"
Accuracy: Cl. 1.6

Pressure Gauges with Diaphragm for PCB Manufacture

PPH

Model: MAN...



Measuring range:
0 ... +1 bar ... 0 ... +25 bar
Housing: Ø 100 mm
Connection: G ¾ male thread
Accuracy: Cl. 1.6

Digital Pressure Gauges with Diaphragm Seals for Homogenizing Machines

Stainless steel

Model: MAN-SD...DRM-189



Measuring range:
0 ... +100 bar ... 0 ... +1000 bar
Housing: Ø 74 mm
Membrane: flush mounted
Connection: for block flange/Thread
Accuracy: Cl. 1.0

Pressure Sensor with Diaphragm Seals for Homogenizing Machines

Stainless steel

Model: SEN...DRM-189...AUF



Measuring range:
0 ... +100 bar ... 0 ... +1000 bar
Membrane: flush mounted
t_{max} 100 °C
Connection: for block flange/Thread
Accuracy: Cl. 1.0

Digital Pressure Gauges with Diaphragm Seals for Homogenizing Machines

Stainless steel

Model: MAN-SF...DRM-189



Measuring range:
0 ... +100 bar ... 0 ... +1000 bar
Housing: Ø 100 mm
Membrane: flush mounted
Display: 4-digit, green LED display
t_{max} 100 °C
Connection: for block flange/Thread
Accuracy: Cl. 1.0

Digital Pressure Gauge with Membrane Diaphragm Seal PVC

PVC

Model: MAN-SD...DRM-630



Measuring range:
0 ... +1.6 bar ... 0 ... +10 bar
Housing: Ø 74 mm
Connection: G ¼, G ½, ½" NPT female
Accuracy: Cl. 1.0

Pressure Sensor with Membrane Diaphragm Seal PP

Polypropylene

Model: SEN...DRM-631



Measuring range:
0 ... +1.6 bar ... 0 ... +10 bar
Connection: G ¼, G ½, ½" NPT female
Accuracy: Cl. 1.0

Pressure Gauge with Membrane Diaphragm Seal

PVDF

Model: MAN-RD...DRM-632



Measuring range:
0 ... +1.6 bar ... 0 ... +16 bar
Housing: Ø 63 mm
Connection: G ¼, G ½, ½" NPT female
Accuracy: Cl. 2.5

Pressure Sensor with Diaphragm Seal and AUF

Stainless steel

Model: SEN...DRM-600



Measuring range:
0 ... +6 bar ... 0 ... +600 bar
t_{max} 70 °C
Connection:
G ½ ... G 1½ male, stainless steel
Accuracy: Cl. 1.0

Pressure Sensor with Plug-on Display and Process Assembly

Brass, Stainless steel

Model: SEN-86 with AUF, KUG-S



Measuring range:
-1 ... 0 bar ... 0 ... +25 bar
Overload protected: 1,5-2 times
Connection: G ½ male thread
Accuracy: Cl. 0.5; 1.0

Pressure Sensor with Ceramic Cell

Stainless steel

Model: PDA



Measuring range:
-1 ... 0 bar ... 0 ... +400 bar
Display: 3-digit LED
Connection: G ¼, G ½, ¼" NPT, ½" NPT male thread
Accuracy: ± 0.5 - 1 % of full scale



Pressure Measurement

Pressure Transmitter

Stainless Steel, Hastelloy-C, Tantalum

Model: PAS

High Quality - Low Cost



Measuring range: -1 ... +600 bar
Power supply: 11.9 - 45 V_{DC}
Connection:
¼" NPT female, ½" NPT female
Accuracy: ± 0.075 % of calibrated span

Pressure Transmitter with Diaphragm Seal

St. steel, Monel, Tantalum, Hastelloy, PTFE

Model: PAS-...N

High Quality - Low Cost



Measuring range:
0 ... +250 mbar ... 0 ... +600 bar
t_{max} 200 °C
Connection: Thread or with flange
(nominal size 15 ... 100)
Accuracy: ± 0.075% of calibrated span +
influence of diaphragm seal

Pressure Transmitter with Diaphragm Seal

St. steel, Monel, Tantalum, Hastelloy, PTFE

Model: PAS-...N

High Quality - Low Cost



Measuring range:
0 ... +250 mbar ... 0 ... +600 bar
t_{max} 350 °C
Connection:
Thread or flange (nominal size 15 ... 100)
Accuracy: ± 0.075% of calibrated span +
influence of diaphragm seal

Pressure Sensor with Ceramic Cell and Plug-On Display AUF

Stainless Steel

Model: SEN-86 with AUF



Measuring range:
-1 ... 0 bar ... 0 ... +600 bar
Display: 4-digit LED
Overload protected: 1.5-2 times
Connection: G ¼, ½" NPT male thread
Accuracy: Cl. 0.5; 1.0

Pressure Sensor with Ceramic Cell and Plug-On Display AUF

Stainless Steel

Model: SEN-87 with AUF



Measuring range:
-1 ... 0 bar ... 0 ... +600 bar
Display: 4-digit LED
Overload protected: 1.5-2 times
Connection: G ¼, ½" NPT male thread
Accuracy: Cl. 0.5; 1.0

Pressure Sensor with Ceramic Cell

Stainless Steel

Model: SEN-96

High Quality - Low Cost



Measuring range:
-1 ... 0 bar ... 0 ... +600 bar
Overload protected: 1.3-5 times
Connection:
G ¼, ½, ¾" NPT, ½" NPT male thread
Accuracy: ≤ ± 1 % of full scale

Pressure Sensor with Ceramic Cell

Stainless Steel

Model: SEN-98/-99



Measuring range:
-1 ... 0 bar ... 0 ... +600 bar (rel)
0 ... 1 bar ... 0 ... +25 bar (abs)
Overload protected: 1.3-5 times
Connection:
G ¼, ½, ¾" NPT, ½" NPT male thread
Accuracy: ≤ 0.25 ... 0.5% of span

Pressure Sensor Compact Piezoresistive

Stainless Steel

Model: SEN-3297 with AUF



Measuring range:
0 ... +1 bar ... 0 ... +6 bar
Membrane: internal
Overload protected: 2 times
Connection:
G ¼, ½, ¾" NPT, ½" NPT male thread
Accuracy: Cl. 1.0

Pressure Sensor Compact Thin Film

Stainless Steel

Model: SEN-3297 with AUF



Measuring range:
0 ... +10 bar ... 0 ... +600 bar
Membrane: internal
Overload protected: 2 times
Connection:
G ¼, ½, ¾" NPT, ½" NPT male thread
Accuracy: Cl. 1.0

Pressure Sensor Industrial Piezoresistive

Stainless Steel

Model: SEN-3276,-3277



Measuring range:
-1 ... 0 bar ... 0 ... +25 bar
Membrane: internal
Overload protected: 2-3.5 times
Connection:
G ¼, ½, ¾" NPT, ½" NPT male thread
Accuracy: ± 0.25 - 0.5 % of full scale

Pressure Sensor Industrial Piezoresistive - Flush Mounted

Stainless Steel

Model: SEN-3251,-3252



Measuring range:
-1 ... 0 bar ... 0 ... +25 bar
Membrane: flush mounted
Overload protected: 2-3.5 times
Connection: G ½, G 1 male thread
Accuracy: ± 0.25 - 0.5 % of full scale

Press. Sensor Industrial Thin Film

Stainless steel

Model: SEN-3376,-3377



Measuring range:
0 ... +40 bar ... 0 ... +1000 bar
Membrane: flush mounted
Overload protected: 1.5-3 times
Connection:
G ¼, ½, ¾" NPT, ½" NPT male thread
Accuracy: Cl. 0.25; 0.5



Pressure Measurement/ Monitoring

Pressure Sensor Precision Piezoresistive/Thin Film

Stainless steel
Model: SEN-3290, -3390



Measuring range:
-0.25 ... 0 bar ... 0 ... +1000 bar
Membrane: internal
Overload protected: 1.5-3.5 times
Connection: G 1/2 male thread
Accuracy: ± 0.1 % of full scale

Pressure Sensor Piezoresistive/Thin Film - Flush Mounted

Stainless steel
Model: SEN-3344, -3386



Measuring range:
0 ... +40 bar ... 0 ... +600 bar
Membrane: flush mounted
Overload protected: 2 times
Connection: G 1/2 male thread
Accuracy: Cl. 0.25; 0.5

Pressure Hand-Held Unit for External Sensors

Model: HND-P210, -215



Measuring range:
-1.999 ... +2.5 mbar ... 0 ... +1000 bar (sensor dependent)
Option: logger, alarm
Accuracy: ± 0.1 % of full scale

Differential Pressure Hand-Held Unit with 2 Integrated Sensors

Model: HND-P121, -123, -126



Measuring range:
-1 ... +25 mbar ... -100 ... +2000 mbar
Option: logger, alarm
Accuracy: ± 0.2 % of full scale

Pressure Hand-Held Unit with 1 Integrated Sensor

Model: HND-P129, -P239



Measuring range: 0 ... +1300 mbar (abs)
Option: logger, alarm
Accuracy: ± 0.2 % of full scale

Pressure Switch with Ceramic Cell

Stainless Steel
Model: PDD



Measuring range:
-1 ... 0 bar ... 0 ... +400 bar
Display: 3-digit LED
Overload protected: 1,5-2 fach
Connection:
G 1/4, G 1/2, 1/4" NPT, 1/2" NPT male thread
Accuracy: ± 0.5 - 1 % of full scale

Electronic Pressure Switch - Thin Film/Ceramic

Stainless Steel
Model: PSC



Measuring range:
-1 ... +2 bar ... 0 ... +700 bar
Display: 4-digit LED
Connection:
G 1/4, G 1/2, 1/4" NPT, 1/2" NPT male thread
Accuracy: ± 1 % of full scale ... ±1 Digit

Pressure Switch with Hall Sensor

Brass, aluminium
Model: PDL-0/-1



Switching range:
-0.9 ... -0.05 bar ... +30 ... +600 bar
Switching function: N/O/N/C
Connection: G 1/4, 1/4" NPT male thread
Repeatability: < 1% of full scale

Pressure Switch - mechanical

Stainless Steel
Model: SCH-27



Switching range:
0.7 ... 6 mbar ... 8 ... 160 bar
Switching function: micro switch
Connection: 1/2" NPT female, 1/4" NPT female, 1/2" NPT male, G 1/2 male
Repeatability: < 1% of switching point

Differential Pressure Switch - mechanical

Stainless Steel
Model: SCH-28



Switching range:
0.1 ... 1 bar ... 0.2 ... 10 bar
Switching function: micro switch
Connection: 1/2" NPT female, 1/4" NPT female, 1/2" NPT male, G 1/2 male
Repeatability: < 1% of switching point

Pressure Gauges Accessories

Brass, steel, stainless steel
Model: MZB



Shut off cocks and valves, syphons, trottler and overpressure protection equipment, adapters

Sandwich Plug-On Display

Model: AUF



Input: 4-20 mA loop powered
Option: Open-Collector
No additional power supply required





Level Switches

Float Magnet Switch

Brass, stainless steel, PVC, PPH, PVDF

Model: M



Density: from 0.5 kg/dm³
 t_{max} 150 °C; p_{max} 100 bar
 Connection:
 thread G/NPT, flange DIN/ANSI

Float Magnet Switch

Brass, stainless steel, PVC, PP

Model: MS



Density: from 0.6 kg/dm³
 t_{max} 150 °C; p_{max} 100 bar
 Connection:
 thread G/NPT, flange DIN/ANSI

Float Bypass Switch

Aluminium, stainless steel

Model: NBA/NBE



Density: 0.65 kg/dm³
 t_{max} 90 °C; p_{max} 10 bar
 Connection: G 3/8 IG, R 1/2 male thread

Plastic Level Switch

Polypropylene, PVDF

Model: NKP



Density: 0.6 kg/dm³
 t_{max} 100 °C; p_{max} 10 bar
 Connection: G 1/2, 1/2" NPT, M16

Float Switch

Stainless steel

Model: RFS



Density: 0.7 kg/dm³
 t_{max} 120 °C; p_{max} 5 bar
 Connection: 1/2" NPT male thread

Float Switch

Brass, stainless steel

Model: NV



Density: 0.7 kg/dm³
 t_{max} 110 °C; p_{max} 16 bar
 Connection: G 3/4 male, M27x1.5 male

Float Switch

Polyethylene, Polypropylene

Model: NSP-S/-K



Density: from 0.6 kg/dm³
 t_{max} 85 °C; p_{max} 2 bar
 Connection: cable

Float Switch

Polypropylene

Model: NAB



Density: 0.5 ... 1.15 kg/dm³
 t_{max} 85 °C; p_{max} 5 bar
 Connection: cable

Float Switch

Polypropylene

Model: NSM



Density: 0.6 kg/dm³
 t_{max} 95 °C; p_{max} 3 bar
 Connection: cable

Float Switch

Polypropylene, Hypalon

Model: NEC



Density: 0.7 ... 1.15 kg/dm³
 t_{max} 85 °C; p_{max} 4 bar
 Connection: cable

Float Switch

PTFE

Model: NST



Density: 0.79 kg/dm³
 t_{max} 150 °C; p_{max} 1 bar
 Connection: cable

Float Switch

Stainless steel

Model: NSE



Density: 0.8 kg/dm³
 t_{max} 150 °C; p_{max} 15 bar
 Connection: G 1/2 male thread

Dual Magnet Float Switch

Stainless steel

Model: NGS

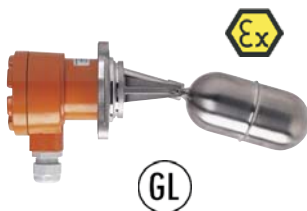

Density: 0.7 kg/dm³
 t_{max} 250 °C; p_{max} 25 bar
 Connection: Square box flange,
 DIN-flange, DN80/100, BSP 2", 2" NPT

Conductive Switch

Stainless steel, Hastelloy, Titanium,
 Coating: Polypropylene, PTFE

Model: NES



t_{max} 150 °C; p_{max} 30 bar
 Connection: G 1/2, G 1 1/2 male thread

Conductive Suspended Electrodes

Stainless steel, Hastelloy, Titanium,
 Neoprene, PVC

Model: NEH



t_{max} 150 °C; p_{max} 6 bar
 Connection: G 1/2, G 1 1/2 male thread

Conductive Switch § 19 WHG

Stainless steel, Hastelloy, Titanium
 Coating: Polypropylene, PTFE

Model: NEW



t_{max} 60 °C; p_{max} atmospheric
 Connection: G 1, G 1 1/2 male thread



Level Switches

Conductive Switch
PP, PPS

Model: NEK



t_{max} 85 °C; p_{max} 20 bar
Connection: G 3/4 male, 3/4" NPT male
Open-Collector or relay

Conductive Switch
Stainless steel, PEEK

Model: LNK



Measuring range: 4 - 1500 mm
 t_{max} 150 °C; p_{max} 10 bar
Connection: G 1/2 male, G 1 male,
hygienic installation system LZE
Open-Collector

Conductive Switch Compact Probe

Stainless steel, PEEK

Model: LNK-K



Measuring range: 4 - 1500 mm
 t_{max} 150 °C; p_{max} 10 bar
Connection: G 1/2 male,
hygienic installation system LZE
Open-Collector

Electrode Relays for Conductive Switches

Model: NE-104, -304



2 limit contacts or
2 Min/Max control switches
Switch capacity: max. 250 V_{AC},
5 A, 600 VA

Electrode Relay § 19 WHG

Model: NE-204



2 limit contacts or
2 Min/Max control switches
Switch capacity: max. 250 V_{AC},
5 A, 600 VA

Head Mounted Transmitter for Conductive Probes

Model: LNR



t_{max} 80 °C
Open-Collector

Microwave Switch

Stainless steel, PEEK

Model: LNM



t_{max} 100 °C (150 °C for CIP); p_{max} 10 bar
Connection: G 1/2, M12 x 1.5 male thread,
hygienic installation system LZE
Open-Collector

Capacitive Switch Liquids

Stainless steel, PEEK

Model: LNZ



t_{max} 100 °C (150 °C for CIP); p_{max} 10 bar
Connection: G 1/2 male thread, hygienic
installation system LZE
Open-Collector

Capacitive Switch Liquids

Stainless steel, PVDF

Model: NCW



t_{max} 90 °C; p_{max} 30 bar
Connection: G 1, G 2 male thread,
Adapter: G 1 1/4, G 1 1/2, round flange,
weld-in sleeve
1 relay, SPDT

Capacitive Switch Liquids - High Temperature

Stainless steel

Model: NCW-H



t_{max} 125 °C; p_{max} 10 bar
Connection: G 1, G 2 male thread,
Adapter: G 1 1/4, G 1 1/2, round flange,
weld-in sleeve
1 relay, SPDT

Ultrasonic Switch Liquids

Stainless steel

Model: NQ-1000



t_{max} 125 °C; p_{max} 20 bar
Connection: R 1 male thread
1 switch output

Optical Switch Liquids

Polypropylene, stainless steel

Model: OPT



t_{max} 80 °C; p_{max} 10 bar
Connection: G 1/2, 1/2" NPT male thread or
M14 with bulkhead nut
Open-Collector

Vibration Switch Liquids

Stainless steel

Model: NWS-***20



t_{max} 130 °C (150 °C for CIP); p_{max} 45 bar
Viscosity: max. 5000 mm²/s
Connection:
R-/NPT-thread, DIN-/ANSI-flange,
Tri-Clamp®, DIN 11851, DIN 11864, DRD

Vibration Switch Liquids - Plug/Cable connection

Stainless steel

Model: NWS-***2*S/F...



t_{max} 90 °C (150 °C for CIP); p_{max} 45 bar
Viscosity: max. 5000 mm²/s
Connection:
R-/NPT-thread, DIN-/ANSI-thread,
Tri-Clamp®, DIN 11851, DIN 11864, DRD

Vibration Switch - Bulk Materials

Stainless steel

Model: NSV



Switching range: 230 - 3000 mm
Density: 0.06 kg/dm³
 t_{max} 80 °C; p_{max} 25 bar
Connection: G 1 1/2 male thread
1 relay, SPDT

Vibration Switch - Bulk Materials

Stainless steel, PE-coating for cable

Model: NVI



Probe length: up to 20 m
Density: 0.05 kg/dm³
 t_{max} 160 °C; p_{max} 25 bar
Connection: G 1 1/2, 1 1/2" NPT male thread
1 relay, SPDT





Level Switches/Transmitters

Diaphragm Switch - Bulk Materials

Neoprene, FPM, steel, st. steel
Model: NMF



t_{max} 200 °C; p_{max} 1 bar (over-pressure secure)
Connection: flange

Rotation Vane Switch - Bulk Materials

Stainless steel
Model: NIR-9/NIR-E9



Measuring range: 65 - 1 000 mm
 t_{max} 200 °C; p_{max} 0.5 bar
Connection: G 1 male thread,
Adapter: G 1 1/4, G 1 1/2, round flange, weld-in sleeve
1 relay, SPDT

Capacitive Switch - Bulk Materials

Stainless steel, PTFE
Model: NSC



Measuring range: 265 - 3 000 mm
 t_{max} 80 °C; p_{max} 0.5 bar
Connection: G 1 male, Adapter: G 1 1/4, G 1 1/2, round flange, weld-in sleeve
1 relay, SPDT

Pendulum Level Monitor Bulk Materials

Aluminium, EPDM
Model: PLS



Pendulum length up to 2 000 mm
 t_{max} 80 °C; p_{max} -0.1 ... 0.5 bar
Process connection: aluminium flange
Contact: max. 250 V_{AC}/3A

Float Transducer - Reed Chain

Stainless steel, PVC-U, PP, PVDF

Model: MM



Measuring range: 300 - 6 000 mm
Density: 0.4 kg/dm³
 t_{max} 130 °C; p_{max} 30 bar
Connection: G 3/4...2 male, 3/4" ... 2" NPT male, flange DN 40 ... 100, ANSI 1 1/2" ... 4"
Accuracy: ± 10 mm

Float Magnetostrictive

Stainless steel

Model: NMT



Measuring range: 300 - 4 000 mm
Density: 0.7 kg/dm³
 t_{max} -20 ... +70 °C; p_{max} PN 10
Connection: G 2, 2" NPT male thread
Analogue output
Accuracy: ± 1 mm

Capacitive Measurement

Stainless steel, PVDF

Model: NMC



Measuring range: 265 - 4 000 mm
 t_{max} 125 °C; p_{max} 30 bar
Connection: G 1, G 2 male thread,
Adapter:
G 1 1/4, G 1 1/2, round flange, weld-in sleeve
Analogue output
Measuring error: 1.5 % of probe length

Potentiometric Measurement

Stainless steel

Model: LNP



Measuring range: 200 - 2 000 mm
 t_{max} 120 (150) °C; p_{max} 10 bar
Connection: G 1, 1" NPT male, hygienic installation system LZE
Analogue output
Accuracy: ± 1 % of probe length

Bypass Glass Gauge

Stainless steel

Model: SZM



Measuring range: 370 - 3 080 mm
 t_{max} 0 ... 100 °C; p_{max} 10 bar
Connection:
flange DN 15 ... 50, ANSI 1/2" ... 2"

Mini Bypass with Roller Indicator

Stainless steel

Model: NBK-M

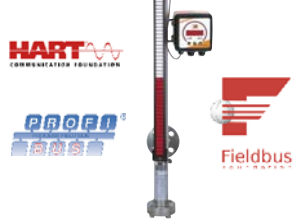

Measuring range: 200 - 3 000 mm
Density: 0.8 kg/dm³
 t_{max} 200 °C; p_{max} PN 40
Connection:
flange DN 10...25, ANSI 1/2" ... 1"
Accuracy: ± 1 mm (transmitter)

Bypass with Roller Indicator

Stainless steel

Model: NBK-03,-06,-07,-10

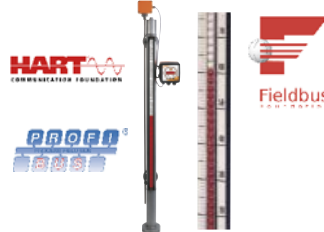

Measuring range: 300 - 5 500 mm
over 5 500 mm 2-piece or multipart
Density: min. 0.54 kg/dm³
 t_{max} 400 °C; p_{max} PN 100
Accuracy: ± 1 mm (transmitter)

Bypass with Roller Indicator - High pressure

Stainless steel

Model: NBK-31,-32,-33



Measuring range: 300 - 5 500 mm
over 5 500 mm 2-piece or multipart
Density: min. 0.54 kg/dm³
 t_{max} 400 °C; p_{max} PN 320
Accuracy: ± 1 mm (transmitter)

Bypass with Roller Indicator

Stainless steel

Model: NBK-ATEX, -GL

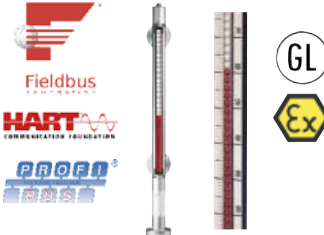

Measuring range: 300 - 5 500 mm
over 5 500 mm 2-piece or multipart
Density: 0.54 kg/dm³
 t_{max} 400 °C; p_{max} PN 100
Accuracy: ± 10 mm (transmitter)

Bypass Over-Top Tank Measurement

Stainless steel

Model: NBK-04/ NBK-04 ATEX



Measuring range: 300 - 4 000 mm
Dichte: 0.43 kg/dm³
 t_{max} 120 °C; p_{max} PN 16
Connection:
flange DN 50, 65 ANSI 2", 2 1/2"
Accuracy: ± 10 mm (transmitter)

Bypass Level Roller Indicator Measurement - Plastic

PP, PVDF

Model: NBK-16,-17



Measuring range: 200 - 4 000 mm
Dichte: 0.57 kg/dm³
 t_{max} 80 °C; p_{max} 4 bar
Connection:
flange DN 20...50, ANSI 3/4" ... 2"
Accuracy: ± 10 mm (transmitter)

Bypass Roller Indicator Low Cost

Stainless steel

Model: NBK-01



Measuring range: 300 - 5 500 mm
over 5 500 mm 2-piece or multipart
Density: 0.54 kg/dm³
 t_{max} 120 °C; p_{max} PN 16
Accuracy: ± 1 mm (transmitter)



Level Switches/Transmitters

Bypass Roll Measuring Rope
PVC

Model: NBK-19



Measuring range: 0.2 - 4.8 m
Density: 1 kg/dm³
t_{max} 60 °C; p_{max} atmospheric
Accuracy: ± 1 mm (transmitter)

Limit Contact for Bypass Measurement

Aluminium, Polycarbonate
Model: NBK-R, RT



t_{max} 400 °C
Switch capacity: 80 VA, 250 V_{AC/DC}, 1 A

Limit Contact for Bypass Measurement

Model: NBK-RA



t_{max} 85 °C
Switch capacity: 45 VA, 230 V_{AC/DC}, 0.6 A

Limit Contact for Bypass Measurement

Model: NBK-RV, -RN



t_{max} 200 °C
Switch capacity: 5 W, 400 V_{DC}/ 230 V_{AC}, 0.5 A

Displacement Level Meter
Stainless steel

Model: BA



Measuring range: 300 - 6000 mm
Density range: 400 - 2000 g/l
t_{max} 250 °C; p_{max} PN 400
Connection: flange DN 50, ANSI 2"
Analogue output, 2 limit contacts
Accuracy: ± 5 mm

Guided Wave Radar (TDR) for process industry - rod probe
Stainless steel, PTFE

Model: NGM



Measuring range: 100 - 3000 mm (liquids)
t_{max} 250 °C; p_{max} 40 bar
Connection: thread, flange
Analogue output, switching output
Accuracy: ± 3 mm or 0.03 % of measured value

Guided Wave Radar (TDR) for process industry - coax probe
Stainless steel

Model: NGM



Measuring range: 100 - 6000 mm (liquids)
t_{max} 250 °C; p_{max} 40 bar
Connection: thread, flange
Analogue output, switching output
Accuracy: ± 3 mm or 0.03 % of measured value

Guided Wave Radar (TDR) for process industry - rope sensor
Stainless steel

Model: NGM



Measuring range: 1000 - 20000 mm (solids and liquids)
t_{max} 150 °C; p_{max} 40 bar
Connection: thread, flange
Analogue output, switching output
Accuracy: ± 3 mm or 0.03 % of measured value

Guided Wave Radar (TDR) for process industry - with Bypass
Stainless steel

Model: NGM



Measuring range: 100 - 3000 mm (liquids)
t_{max} 250 °C; p_{max} 40 bar
Connection: thread, flange
Accuracy: ± 3 mm or 0.03 % of measured value

Guided Wave Radar (TDR) for machines/factory automation
Stainless steel, PTFE

Model: NGR



Measuring range: 200 - 4000 mm (liquids)
t_{max} 100 °C; p_{max} 10 bar
Connection: G ¾, ¾" NPT male
Analogue output, switching outputs
Accuracy: ± 5 mm

Ultrasonic Measurement
PP, PVDF

Model: NUS-7



Measuring range: 0.25 - 6 m (liquids)
t_{max} 80 °C; p_{max} 3 bar abs
Connection: G 2, 2" NPT
Analogue output
Accuracy: ± 0.2% of reading ± 0.05% of full scale

Ultrasonic Measurement
PP, PVDF

Model: NUS-4



Measuring range: 0.2 - 25 m (liquids)
0.2... 10 m (bulk)
t_{max} 90 °C; p_{max} 3 bar abs
connection: G 1½, G 2, 1½" NPT, 2" NPT male, DN 80, DN 125, DN 150, ANSI 3", 5", 6"
Analogue output
Accuracy: ± 0.2% of reading ± 0.05 % of full scale

Differential Pressure Transmitter with Diaphragm Seal
St. steel, Monel, Tantalum, Hastelloy, PTFE

Model: PAD-...N



Level:
0 ... +2500 mmWC ... 0 ... +150 mWC
t_{max} 200 °C
Connection: flange via neck tube DN 50 or bigger
Accuracy: ± 0.075% of calibrated span + influence of diaphragm seal

Pressure Transmitter with Diaphragm Seal
St. steel, Monel, Tantalum, Hastelloy, PTFE

Model: PAS-...N



Level:
0 ... +2500 mmWC ... 0 ... +150 mWC
t_{max} 350 °C
Connection: Thread or flange DN 50 or bigger
Accuracy: ± 0.075% of calibrated span + influence of diaphragm seal

Deep-Well Probe
Stainless steel, cable polyurethane

Model: NTB



Measuring range: 0 - 1 ... 0 - 300 mWS
Analogue output
Cable length: 200 m
Accuracy: ± 0.5 % of full scale

Hydrostatic Diaphragm Measurement
Stainless steel

Model: NPF



Measuring range: 0 - 600 ... 0 - 10000 mmWS
t_{max} 80 °C
Connection: G ½ male, ½" NPT, DN 50 ... DN 100, ANSI 2" ... 4"
Accuracy: ± 1.6 % of full scale





Temperature Switches/indicators

Bi-metal Switch

Brass, stainless steel

Model: TWR



Switching range: +30 ... +120 °C
 t_{max} 150 °C; p_{max} 64 bar
 Connection: G 3/4 male thread

Thermal Reed Switch

Brass, stainless steel

Model: TRS



Switching range: 10 ... 120 °C
 t_{max} 120 °C; p_{max} 25 bar
 Connection: G 1/4...1, 1/4...1" NPT

Temperature Switch Digital

Stainless steel

Model: TDD-1, -3, -5, -7



Measuring range: -20 ... +120 °C
 t_{max} 125 °C; p_{max} 80 bar
 Connection:
 G 1/2, G 3/4, 1/2" NPT, 3/4" NPT male thread
 2 limit contacts
 Accuracy: ± 0.5 °C

Temperature Switch Digital

Stainless steel

Model: TDD-...D6



Measuring range: -50 ... +125 °C
 t_{max} 125 °C; p_{max} 80 bar
 Connection: smooth probe \varnothing 6 mm
 2 limit contacts
 Accuracy: ± 0.5 °C

V-Form - Machinery Glass Thermometer

Aluminium casing, brass

Model: TGL



Measuring range:
 -60 ... +40 °C ... 0 ... +200 °C
 Connection: G 1/2, 1/2" NPT male thread
 Accuracy: $\pm 1\%$ of full scale

V-Form - Machinery Glass Thermometer

Plastic casing, brass

Model: TGK



Measuring range:
 -60 ... +40 °C ... 0 ... +200 °C
 Connection: G 1/2, 1/2" NPT male thread
 Accuracy: $\pm 1\%$ of full scale

Bi-metal Thermometer

Copper alloy, steel, stainless steel

Model: TBI-I/ TBI-S



Measuring range: -30 ... +500 °C
 p_{max} 25 bar
 Connection:
 G 1/2 male thread, welding sleeve
 Accuracy: Cl. 1.0 according to VDI

Bi-metal Thermometer

Stainless steel

Model: TBE



Measuring range:
 -50 ... +50 °C ... 0 ... +600 °C
 p_{max} 15 bar
 Connection: G 1/2 ... 3/4, 1/2" ... 3/4" NPT,
 fixed, rotatable, slidable
 Accuracy: Cl. 1.0

Shaft Thermometers according to DIN 16205

Stainless steel

Model: TNS



Measuring range: -40 ... +600 °C
 p_{max} 25 bar
 Connection: G 1/2...1, 1/2...1" NPT,
 DIN 11851, Tri-Clamp®, helix probe
 Accuracy: Cl. 1.0; 1.6

Capillary Thermometer according to DIN 16206

Stainless steel

Model: TNF



Measuring range: -40 ... +600 °C
 p_{max} 25 bar
 Connection: G 1/2...1, 1/2...1" NPT,
 DIN 11851, Tri-Clamp®, helix probe
 Accuracy: Cl. 1.0; 1.6

Safety Thermometer with Contacts

Stainless steel

Model: TNS, TNF



Measuring range: -40 ... +600 °C
 p_{max} 25 bar
 Connection: G 1/2...1, 1/2...1" NPT,
 DIN 11851, Tri-Clamp®, helix probe
 Accuracy: Cl. 1.0; 1.6

Shaft Thermometer for Diesel Engines

Steel, stainless steel

Model: TND



Measuring range: 0 ... +800 °C
 p_{max} 25 bar
 Connection: G 1/2, G 3/4 male thread
 Accuracy: Cl. 1.0; 1.6

Thermowells for Shaft, Capillary and Resistance Thermometer

Stainless steel, Special

Model: TWL-0



t_{max} 800 °C; p_{max} 250 bar
 Connection:
 thread, flange, welding sleeve

Electronic Temperature Sensor

Stainless steel

Model: TDA



Measuring range: -20 ... +120 °C
 p_{max} 80 bar
 Connection:
 G 1/2, G 3/4, 1/2" NPT, 3/4" NPT male thread
 Analogue output, limit contact
 Accuracy: ± 0.5 °C

Electronic Temperature Sensor

Stainless steel

Model: TDA-...D6



Measuring range: -50 ... +125 °C
 p_{max} 80 bar
 Connection: smooth probe \varnothing 6 mm
 Analogue output, limit contact
 Accuracy: ± 0.5 °C

Infrared Fixed Thermometer

Stainless steel

Model: TIR-FA



Measuring range:
 0 ... +120 °C ... 100 ... +500 °C
 10 mV/K or voltage model J, K
 Accuracy:
 $\pm 1.5\%$ of measuring range or 2.5 °C



Temperature Switches/indicators

Infrared Fixed Thermometer

Stainless steel
Model: TIR-SN/FS/FG



Measuring range:
-20 ... +300 °C ... +1100 ... +2500 °C
Analogue output
Accuracy: ± 1.5 % of measuring range / °C
0.8 ... 1 % of reading + 1 °C

Precision Hand-Held Thermometer

Model: HND-T120



Measuring range: -50 ... +1150 °C
Sensor: Type K (NiCr-Ni)
Accuracy: 1 - 1.5 % of reading

Precision Hand-Held Thermometer

Model: HND-T125



Measuring range: -50 ... +1150 °C
Sensor: Type K (NiCr-Ni)
Accuracy: ± 0.2 of full scale ± 0.05 ... 0.1 % of reading

Precision Hand-Held Thermometer

Model: HND-T105, -T205, -T110



Measuring range: -65 ... +1768 °C
Sensor:
Pt 100 or thermocouple types K, N, S
Option: Logger, alarm, control function
Accuracy: ± 0.03 % of full scale

Double / Differential Hand-Held Thermometer

Model: HND-T115, -T215



Measuring range: -220 ... +1750 °C
Sensor: thermocouple types K, N, S, J, T
Accuracy: ± 0.03 % of reading

Digital Thermometer

Stainless steel
Model: DTM



Measuring range: -30 ... +400 °C
p_{max} 25 bar
Connection: G ½...1, ½...1" NPT
Analogue output, 2/4 limit contacts
Accuracy: Cl. 0.5

Temperature Sensor

Brass, stainless steel
Model: TSA



Measuring range: -40 ... +150 °C
t_{max} 150 °C; p_{max} 25 bar
Connection: G ¼...1, ¼...1" NPT
Accuracy: from 0.7 °C

Resistance Thermometer

Brass, bronze, stainless steel
Model: TNK



Measuring range: -80 ... +150 °C
t_{max} 150 °C; p_{max} 50 bar
Connection: M18x1.5; G ½; ½" NPT
Accuracy: Cl. A or B

Screw-In Resistance Thermometer

Brass, stainless steel
Model: TMA with AUF and KUG-S



Measuring range:
0 ... +50 °C ... -200 ... +600 °C
p_{max} 36 bar
Accuracy: Cl. B

Resistance Temperature Probe with Connection Box

Model: LTS-A



Measuring range: -50 ... +250 °C
p_{max} 10 bar
Connection: G ½, M12x1.5 male, hygienic installation system LZE
Pt 100, 4...20 mA
Accuracy: Cl. A

Resistance Temperature Probe - Compact Version

Stainless steel
Model: LTS-K



Measuring range: -50 ... +250 °C
p_{max} 10 bar
Connection: G ½, M12x1.5 male, hygienic installation system LZE
Pt 100, 4...20 mA
Accuracy: Cl. A

Temperature Transducer - Head, Rail or Wall Mounting

Model: KM-1/-3/-6



Measuring range:
-200 ... +250 °C ... -50 ... +1768 °C
Input: RTD, TC, Ω, mV
Analogue output

Industrial - Resistance Thermometer

Stainless steel
Model: MWD

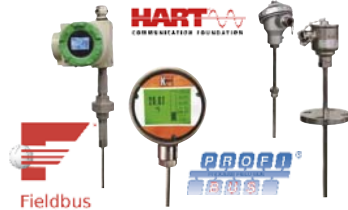

Measuring range:
-70 ... +250 °C ... -200 °C ... +600 °C
p_{max} 40 bar
Accuracy: Cl. A or B

Screw-In Resistance Thermometer according to DIN

Stainless steel
Model: TWD-B



Measuring range: -80 ... +600 °C
p_{max} 25 bar (40 bar)
Connection: G ½...1, ½...1" NPT
Analogue output
Accuracy: Cl. A or B

Weld-In and Insertion Resistance Thermometer according to DIN

Stainless steel
Model: TWD-D, -F



Measuring range: -80 ... +600 °C
p_{max} 25 bar (40 bar)
Analogue output
Accuracy: Cl. A or B

Digital Thermometer - Battery powered

Stainless steel
Model: DTB



Measuring range: -50 ... +200 °C
p_{max} 34 bar
Display: 4-digit, LCD
Connection: compression fitting
G ¼ ... ¾, ¼" ... ¾" NPT
Accuracy:
± (0.2 + 0.002 x measured value) °C





Temperature Indicators

Screw-In Resistance Thermometer

Stainless steel

Model: TWE-1



Measuring range: -20 ... +600 °C
Connection: G 1/4, G 1/2, M10
Accuracy: Cl. A or B

Screw-In Resistance Thermometer

Stainless steel

Model: TWE-2



Measuring range: -20 ... +400 °C
Connection: M10
Accuracy: Cl. A or B

Screw-In Resistance Thermometer

Stainless steel

Model: TWE-3



Measuring range: -20 ... +300 °C
Connection: M8
Accuracy: Cl. A or B

Insertion Resistance Thermometer

Stainless steel

Model: TWE-5



Measuring range: -20 ... +350 °C
Accuracy: Cl. A or B

Immersion-/Insertion Resistance Thermometer

Stainless steel

Model: TWE-6, -7, -8



Measuring range: -20 ... +350 °C
Accuracy: Cl. A or B

Screw-In Resistance Thermometer

Stainless steel

Model: TWE-K



Measuring range: -20 ... +150 °C
Connection: G 1/4, G 1/2, G 3/4, M12
Accuracy: Cl. A or B

Sheath Resistance Thermometer

Stainless steel

Model: TWM



Measuring range: -20 ... +600 °C
Accuracy: Cl. A or B

Resistance Temperature Measuring Unit

Stainless steel

Model: TWL

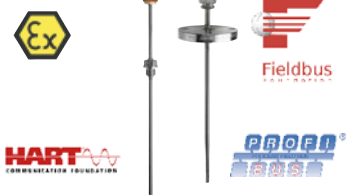

Measuring range: -80 ... +600 °C
p_{max} 250 bar
Connection: thread, flange, weld-in sleeve
Pt 100, 4...20 mA
Accuracy: Cl. A or B

Room Thermometer

Aluminium

Model: TWL-ST

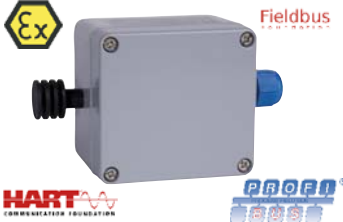

Measuring range: -20 ... +60 °C
p_{max} atmospheric
Wall socket
Pt 100, 4...20 mA
Accuracy: Cl. A or B

Contact Resistance Thermometer

Aluminium, stainless steel

Model: TWA



Measuring range: -20 ... +260 °C
Accuracy: Cl. A or B

Weld-In and Insertion Thermocouples according to DIN

Steel, stainless steel, ceramic

Model: TTD



Measuring range: -200 ... +1150 °C
p_{max} 25 bar (40 bar)
Connection: G 1/2 male thread
Accuracy: Cl. 1.0

Screw-In Thermocouples with Compensating Lead

Stainless steel

Model: TTE-1



Measuring range: -200 ... +600 °C
Connection: G 1/2, M10x1
Accuracy: Cl. 1.0

Insertion Thermocouples with Bayonet Lock

Stainless steel

Model: TTE-5



Measuring range: 0 ... +400 °C
Accuracy: Cl. 1.0

Immersion-/Insertion Thermocouples with Compensating Lead

Stainless steel

Model: TTE-6, -8



Measuring range: 0... +600 °C
Accuracy: Cl. 1.0

Immersion and Insertion Thermocouples

Stainless steel, Alloys

Model: TTL



Measuring range: -200 ... +1100 °C
p_{max} 250 bar
Connection: thread, flange, weld-in sleeve
4...20 mA
Accuracy: Cl. 1.0 or 2.0

Sheath - Thermocouples

Brass, stainless steel

Model: TTM



Measuring range: -50 ... +1100 °C
Accuracy: Cl. 1.0



Transmitter for pH-Value and ORP
Model: APM-1



Outputs: 1 binary output,
2 analogue outputs
Switch output:
2 relays with adjustable setpoints

pH-Combined Electrodes
Glass, plastic



Measuring range: pH 0...14
 t_{max} 135 °C; p_{max} 10 bar
Diaphragm: PTFE-ring, ceramic

pH-, Redox- and Temperature Hand-Held Measurement



Measuring range: pH: 0...14;
Redox: -1999...+2000 mV
Temperature: -5...+150 °C
Accuracy: ± 0.01 pH; $\pm 0.1\%$ of full scale

Transmitter for Specific Conductivity



Measuring range: 0...200 mS/cm
Outputs: 1 binary output,
2 analogue outputs
Switch output:
2 relays with adjustable setpoints

Conductive/Inductive Conductivity Measuring Cells

Stainless steel, graphite
Model: ACS



Measuring range: 0,05 μ S/cm... 15 mS/cm
 t_{max} 135 °C; p_{max} 16 bar
Process connection: G $\frac{3}{4}$ male thread

Inductive Conductivity Measuring System

PEEK, PVDF, stainless steel
Model: LCI



Measuring range: 0...2000 mS/cm
 t_{max} 140 °C; p_{max} 10 bar
integrated Pt100
Accuracy: $\pm 0.5 - 1\%$ of full scale

Hand-Held Conductivity Measuring Unit



Measuring range:
0...200 μ S/cm -0... 200 mS/cm
Resistance, salinity, TDS
Accuracy: from $\pm 0.1\%$

Humidity/Temperature Transmitter



Measuring range: 0...100 % rH;
-60...200 °C
 t_{max} 200 °C; p_{max} 25 bar
Outputs: 2 x 4...20 mA
Accuracy: $\pm 2\%$ rH

Humidity Transmitter with Display



Measuring range: 5...95 % rH; 0...60 °C
 t_{max} 80 °C
Outputs: 4...20 mA
Accuracy: $\pm 2\%$ rH

Humidity/Temperature Transmitter



Measuring range: 0... 100% rH;
-40...+180 °C
 t_{max} 180 °C; p_{max} 15 bar
Outputs: analogue outputs and switches
Accuracy: $\pm 1.6\%$ of reading % rH

Hygostat, Humidity Annex Switch



Measuring range: 30... 100 % rH
 t_{max} 60 °C
Switch output: 1 SPDT
Accuracy: 3 % rH

Hand-Held Humidity Precision Measuring Unit



Measuring range: 0... 100% rH
integrated Pt1000
Accuracy: $\pm 0.1 - 0.2\%$

Turbidity Measuring System



Measuring range: 0... 500 ppm;
0... 4 CU, 0...10 - 200 FTU
 t_{max} 150 °C; p_{max} 16 bar
Outputs: 4...20 mA
Accuracy: $\pm 2\%$ of full scale

Transmitter for Turbidity Measuring System



Ausgänge: 4...20 mA
Switch output:
2 alarm contacts ((potential-free SPDT),
1 Alarm (lamp and function control)

Turbidity Probe



Measuring range: 0... 500 ppm; 0... 4 CU
 t_{max} 90 °C; p_{max} 10 bar
Outputs: 4...20 mA
Accuracy: $\pm 2\%$ of full scale

Density Meter



Measuring range: 700... 1900 g/l
 t_{max} 150 °C
Process connection:
flange DN 25...50, ANSI 1"... 2"
Accuracy: $\pm 1.25... 6$ g/l





Food and Pharmaceutical

Calimetric Meter/Switch

Stainless steel
Model: KAL-K4440



Water: 0,04 – 2 m/s
 t_{max} 120 °C; p_{max} 100 bar
Connection: G 1/4...1 1/2, 1/4...3/4" NPT, M12, Tri-Clamp®

Variable Area - All Metal

Stainless steel, special material
Model: BGN-...E



Water: 0,5 – 5 l/h ... 13000 – 130000 l/h
Air: 0,015 – 0,15 Nm³/h ... 240 – 2400 Nm³/h
 t_{max} 350 °C; p_{max} PN 40
Connection: DIN 11851 DN 20...100
Accuracy: \pm 1.6 – 2.2 % of full scale

Electromagnetic Measurement

Stainless steel, PTFE, PVDF
Model: DMH



Water: 0 – 1 m³/h ... 0 – 280 m³/h
 t_{max} 150 °C; p_{max} PN 40
Connection: 1/2" ... 4" Tri-Clamp®, DN 15... DN 100 sanitary acc. to DIN 11851
Accuracy: \pm 0.3% of reading \pm 0.01% of full scale

Contact Pressure Gauge with Diaphragm Seal, DIN 11851

Stainless steel
Model: MAN-RF...M21...DRM-602



Measuring range: 0 – 1 bar ... 0 – 40 bar
Housing: \varnothing 100, 160 mm
Connection: DIN 11851 DN 20... 100
Accuracy: Cl. 1.6

Digital Pressure Gauges with Diaphragm Seals for Homogenizing Machines

Stainless steel
Model: SEN...DRM-189...AUF



Measuring range: 0 ... +100 bar ... 0 ... +600 bar
Membrane: flush mounted
 t_{max} 100 °C
Connection: for block flange
Accuracy: Cl. 1.0

Conductive Switch/ Compact Probe

Stainless steel, PEEK
Model: LNK-K



Measuring range: 4 – 1500 mm
 t_{max} 150 °C; p_{max} 10 bar
Connection: G 1/2 male, G 1 male, hygienic installation system LZE
Open-Collector

Microwave Switch

Stainless steel, PEEK
Model: LNM



t_{max} 100 °C (150 °C for CIP); p_{max} 10 bar
Connection: G 1/2, M12 x 1.5 male, hygienic installation system LZE
Open-Collector

Capacitive Switch Liquids

Stainless steel, PEEK
Model: LNZ



t_{max} 100 °C (150 °C for CIP); p_{max} 10 bar
Connection: G 1/2 male, hygienic installation system LZE
Open-Collector

Capacitive Switch Bulk Materials

Stainless steel, PTFE
Model: NSC



Measuring range: 265 – 3000 mm
 t_{max} 80 °C; p_{max} 0,5 bar
Connection: G 1 male, Adapter: G 1 1/4, G 1 1/2, round flange, weld-in sleeve
1 relay, SPDT

Potentiometric Measurement

Stainless steel, PEEK
Model: LNP



Measuring range: 200 – 2000 mm
 t_{max} 120 °C; p_{max} 10 bar
Connection: G 1, 1" NPT 1 relay, SPDT
Analogue output
Accuracy: \pm 1 % of probe length

Vibration Switch Bulk Materials

Stainless steel
Model: NSV



Measuring range: 230 – 3000 mm
Density: 0.06 kg/dm³
 t_{max} 80 °C; p_{max} atmospheric
Connection: G 1 1/2 1 relay, SPDT
1 relay, SPDT

Vibration Switch Liquids

Stainless steel
Model: NWS-...2ES



t_{max} 130 °C (150 °C for CIP); p_{max} 50 bar
Connection: R-/NPT-thread, DIN-/ANSI-flange, Tri-Clamp®, milk connection DIN 11851, Aseptic DIN 11864, DRD-flange

Rotation Vane Switch - Bulk Materials

Stainless steel
Model: NIR-9/E9



Measuring range: 65 – 4000 mm
 t_{max} 200 °C; p_{max} 0.5 bar
Connection: G 1 male, Adapter: G 1 1/4, G 1 1/2, round flange, weld-in sleeve
1 relay, SPDT

Resistance Temperature Probe with Connection Box/Compact Version

Stainless steel
Model: LTS-A/-K



Measuring range: -50 ... +250 °C
 p_{max} 10 bar
Connection: G 1/2, M12 x 1.5 male thread, hygienic installation system LZE
Pt 100, 4...20 mA
Accuracy: Cl. A

Capillary Thermometer according to DIN 16206

Steel, aluminium, stainless steel
Model: TNF



Measuring range: -40 ... +40 °C ... 0 ... +600 °C
 p_{max} 25 bar
Connection: G 1/2...1, 1/2...1" NPT, DIN 11851, Tri-Clamp®, helix probe
Accuracy: Cl. 1.0; 1.6

Hygienic Mounting Systems

Stainless steel
Model: LZE



t_{max} 250 °C; p_{max} 10 bar
M12x1.5; G 1/2; G 1
Seals: metallic, PEEK-ring



Flow Regulators
Brass, stainless steel

Model: REG

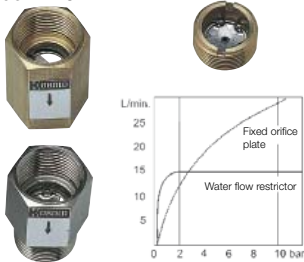

Viscosity range: 1 – 30 mm²/s
Water: 0,5 – 40 l/min
t_{max} 300 °C; p_{max} 200 bar
G ½, G ¾, ¼" NPT

Flow Regulators - Multiple Element
Brass, stainless steel

Model: REG-8



Viscosity range: 1 – 30 mm²/s
Water: 1 – 280 l/min
t_{max} 300 °C; p_{max} 200 bar
Flange DN 20...50

Flow Regulators - Multiple Element
Brass, stainless steel

Model: REG-9



Viscosity range: 1 – 30 mm²/s
Water: 1 – 280 l/min
t_{max} 300 °C; p_{max} 200 bar
G 1½...G 2½

Brass/Stainless Steel Ball Valves
Model: KUG-TB, -VN, -VC/KUG-ZE, -KD



t_{max} 180 °C; p_{max} PN 64
G ¼... 4 female thread
hand level, 1-, 2- and 3-piece versions

Grey Cast Iron/Stainless steel- Flange - Ball Valves

Model: KUG-VO, -VK



t_{max} 180 °C; p_{max} PN 40
Flange DN 15...200
according to DIN 3202 F4/5

Ball Valves Shut-off for Measuring Device
Brass, stainless steel

Model: KUG-S



t_{max} 120 °C; p_{max} PN 25
G ½...2 female thread
Sensor support: G ¼, G ½

Brass/Stainless steel Ball Valves with Pneumatic Actuator

Model: KUP-KA, -VN, -ZA, -VH, -PD



t_{max} 120 °C; p_{max} PN 16
G ½...4 female thread
Control pressure: 6 – 8 bar
Single or double acting
T- and L-bore

Grey Cast Iron/Stainless steel- Flange Ball Valves with Pneumatic Actuator

Model: KUP-VO, -VK



t_{max} 160 °C; p_{max} PN 16
Flange DN 15...200
Control pressure: 6 – 8 bar
Single or double acting

Accessories for Pneumatic Actuator

Model: KUP-RE



3/2- and 5/2-way solenoid valve several volgates, mechanical limit switch and proximity switch

Butterfly Valves
Aluminium, GGG-40

Model: KLA



t_{max} 180 °C; p_{max} PN 16
Flange DN 40...300
Seals: NBR, FKM, PTFE

Butterfly Valves with Pneumatic Actuator

Aluminium, GGG-40

Model: KLP



t_{max} 160 °C; p_{max} PN 16
Flange DN 40...300
Seals: EPDM, FKM
Control pressure: 6 – 8 bar
Double acting or spring resetting

Needle Valve
Brass

Model: NAD-AC



t_{max} 100 °C; p_{max} PN 100
G ½...2 female thread

Needle Valve - Stainless Steel

Model: NAD-M, -Z



t_{max} 400 °C; p_{max} PN 250
G ½...1¼, ½...1" NPT

Angle Seat Valves
Brass, stainless steel

Model: NAD-AD, -BE



t_{max} 180 °C; p_{max} PN 16
G ¾...3 female thread

Outlet Globe Valves
Brass, stainless steel

Model: NAD-AB, -BF



t_{max} 130 °C; p_{max} PN 16
G ¾...3

Check Valves
Red cast iron, brass, stainless steel

Model: KUR-TD, KUR-MR



t_{max} 110 °C; p_{max} PN 25
G ¼...4 female thread





Assemblies, Control Devices and Relays

Threaded Magnetic Filter
Bronze, brass
Model: MFR



t_{max} 200 °C; p_{max} PN 16
Rp ½...3 female thread
Filter grade: 280 µm

Magnetic Filter Dirt Trap
Brass, stainless steel
Model: MFR-IG, MFR-EA



t_{max} 180 °C; p_{max} PN 40
G ¾...2 female thread
Filter grade: 250 µm

Flange Magnetic Filter
Grey cast iron
Model: MFF



t_{max} 200 °C; p_{max} PN 16
R ½...3, soldering connection
22...35 mm, flange DN 50...200
Filter grade: 750 µm

Contact Protection Relay
Model: MSR

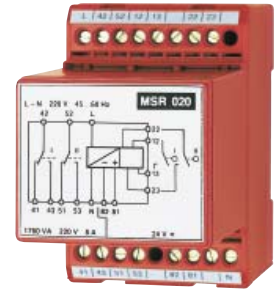

Input: potential-free contacts
1 or 2 relay outputs, SPDT

Isolation Switching Amplifier for Initiators
Model: KFD-2, KFA-6



Input:
Initiators (Namur), potential-free contacts
1 relay, SPDT

Sandwich Plug-On Display
Model: AUF



Input: 4 - 20 mA loop powered
Option: Open-Collector
Without additional power supply

Digital - Panel Mount - Indicators
Model: DAG-A/S/M



Input: current, voltage, temperature, frequency, resistance
Analogue output, limit contacts
Min/Max-memory

Universal Indicator
Model: ADI-1



Input: current, voltage, frequency
Analogue output, 2 limit contacts, sensor supply

Universal Indicator
Model: ADI-1...S



Input: current, voltage, frequency
Analogue output, 2 limit contacts, sensor supply

Industrial Dosing, Counter and Flow Indicator
Model: ZOK



Input: frequency
Analogue output, limit contacts, sensor supply, battery powered

Electronic for Measuring and Monitoring
Model: ZED-K



Input: frequency
Analogue output, 2 limit contacts, sensor supply

Batch Controller
Model: ZED-D



Input: frequency
Analogue output, 2 limit contacts, sensor supply

Counter Electronics
Model: ZED-Z



Input: frequency
Analogue output, 2 limit contacts, sensor supply

Counter Electronics/ Batch Controller
Model: DAG-Z2



Input: frequency
limit contacts, sensor supply

Universal Panel Meter
Model: DAG-T4



Input:
current, voltage, Pt 100, thermocouples
limit contacts, sensor supply

Electronic Multi - Channel Data Logger
Model: ZLS



Input: 4 - 20 mA, Pt 100, Pt 500, Pt 1000
interface, sensor supply



Steam Flow Measurement

-Complete solutions from one source-

Applications

Example based on a differential pressure transmitter

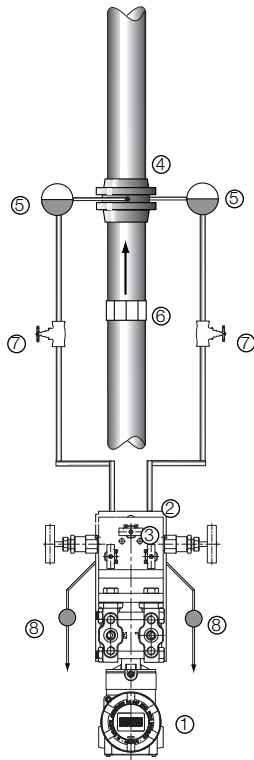

A complete measuring system comprises of:

- ① Differential pressure transmitter PAD
- ② Flat bracket for pipe mounting ZUB-PAD/PAS-L
- ③ 5-way Block valve as accessory PAD
- ④ Orifice flange including orifice plate KPL
- ⑤ Steam condensate chambers as accessory KPL
- ⑥ Flow conditioner as accessory KPL
- ⑦ Shut-off valve as accessory KPL
- ⑧ Separator as accessory KPL

We will gladly prepare a customised offer for you.

Highly accurate steam flow measurement with Vortex flowmeter DVH/DVE from Heinrichs Messtechnik

Steam is one of the most commonly used media in the process industry. It is used for example to heat tanks, pipes or produced for cleaning and sterilizing purposes in various industries.

In all cases, first of all, steam must be generated.

The generation of steam is extremely energy-intensive and for this reason expensive. Therefore it is logical not only to measure the generated steam but also the amount of steam required by the consumer. The more accurately it is done, the more energy-efficient and therefore the more economically the steam can be generated. In times of high energy costs and dwindling resources, precision is required in handling these precious commodities.

The vortex flowmeters from Heinrichs are highly accurate and always offer a functionality tailored specifically for each steam application.

All devices can be equipped optionally with an integrated pressure and temperature measurement, which allows the state of the steam to be determined precisely. The "Energy Monitoring" option which incorporates an additional external temperature sensor, makes energy consumption measurement possible. With up to 3 analogue outputs and 3 alarm outputs, pulse output, and MODBUS interface. The devices offer a vast communication spectrum for the users. A fully welded sensor design without seals also ensures stability and long-life cycle. In-line devices cover pipes up to DN 200 (8"). For bigger sizes an insertion type variant, for up to DN 600 (24") is available.

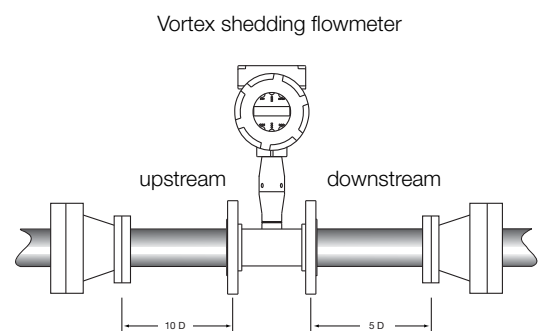

Applications

Fuel Consumption in Diesel Engines

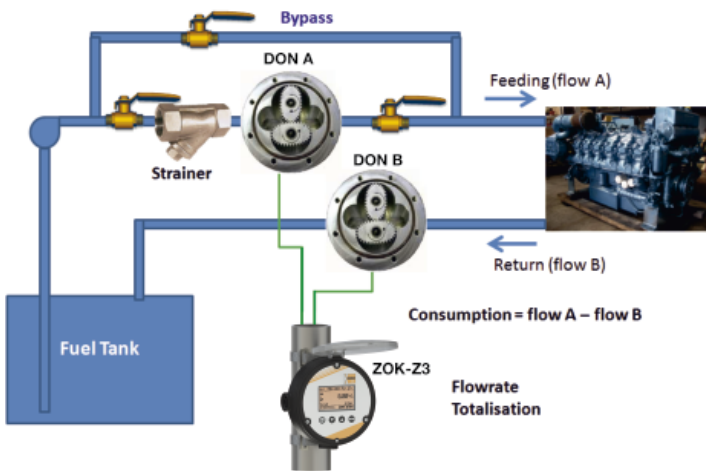

Oval Wheel Flow Meters Model DON may be used for fuel consumption measurement in diesel engines using the dual flow inputs and the 'A-B' setting. A pair of DON flowmeters is used with a single electronic model ZOK-Z3 to give a net reading of fuel consumption.

In this off-shore application, a fuel consumption measurement system has been effectively implemented on diesel engines in small ships/ vessels. Here we used a pair of stainless steel flowmeters (DON-S15... for flows upto 550 l/h per flowmeter) and one ZOK-Z3 per engine. As choking of the flowmeter or strainer in main line may result in higher differential pressure and result in diminishing fuel to the engine, an alternative is to use a pressure relief valve in the bypass line. Higher inlet pressure opens the pressure relief valve and ensures a constant supply to the diesel engine. In selective cases, the choice of „pulsating flow” option may be recommendable.

With this installation, the fishermen are now in a position to monitor the actual real time fuel consumption and adapt the ship speed to optimise it. In general, the return of investment is implemented within a month.

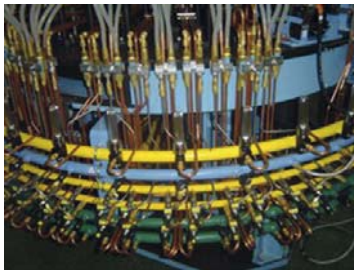

Optimum Gas Burner Monitoring for No Product Rejection

Task:

Lighting machine manufacturers generally require several smaller and a bigger annual maintenance on their production lines. The maintenance requires shutting down of production lines and dismantling them completely. All failures need to be fixed, broken or worn parts replaced, burners and valves refurbished and the production lines reassembled.

It is only after such maintenance, that the production of rejected goods may restart.

Each production phase of the renewed line must sync again, each burner must be reset at the right temperature and the entire production process must be adjusted to manufacture the best quality products. This requires not only precision but consumes a lot of time during trial and again leads to a lot of rejected goods. The time consumed and the wasted goods cost money, increase the product cost and result in competitive disadvantage in the market.

Solution:

The production lines can be equipped with UTS type variable area flow meters. One UTS may be built into each gas circuit for gas burner control. Retrofitting of machines without major modification even with 10-20 flow meters is an easy job due to the small footprint of UTS and its compact design.



When production line produces a perfect product, the displayed values of the instruments are recorded. Following next shutdown of production lines and before starting the conveyor-belt, all burners are set up to recorded value with the help of UTS.

It takes only a few seconds to set each burner. Customer could start the continuous production in a short span of time as the quality of first finished product is already perfect. The total investment is returned after only a few maintenance cycles.



Biogas flow measurement



Task:

Biogas usually refers to gas generated from organic substance in the absence of oxygen. The source of this kind of bio-fuel is organic waste which can be found in many forms including animal waste, human waste, dead plant and other decaying organic matter. As with any other fuel gas, biogas mainly contains Methane (CH₄) and Carbon Dioxide (CO₂).

It is not that hard to understand that harvesting biogas from waste has two advantages, the first one of course you get 'free' energy while at the same time you play your part in keeping the earth greener by reducing the amount of greenhouse gases released to the atmosphere.

Looking at the economical potentiality, companies who own palm plantations are nowadays starting to build and operate their own biogas plants, utilizing vast amount of organic waste from the plantation they run.

One thing you always need to do when running a plant is to make sure that your plant is running efficiently. The simplest or most straight

forward way to achieve this objective is to measure the output of your plant, in this case, the volume of biogas generated.

Measuring the total amount of biogas generated in a biogas plant can be tricky, because you have to deal with a low operating pressure which can be as low as 100 mBar (even at a point downstream of a blower) while on the other hand you have to also consider that biogas is a dirty, humid gas and has the potential to corrode the metal part of the flow meter. And to make it more interesting, biogas is flammable, of course. So, hazardous area certification is a must.

As with any other gas, biogas is compressible, which means that its density varies greatly when there is a change in operational pressure and/or operational temperature. Therefore the operational pressure and temperature must be evaluated to ensure an accurate flow measurement.

Solution:

KOBOLD DOG Oscillation Type - Gas Flow Meter. Thanks to the 'oscillation' working principle and generously dimensioned flow measuring channels, this unit is extremely dirt resistance and has a self cleaning effect, which is crucial for a dirty fluid like biogas. Also as this flow meter has no rotating parts, the pressure drop can be kept to a minimum. One can expect a maximum 50 mbar pressure drop at Q_{max} when the DOG measures gas with the same density as air. And it comes with ATEX II 1G EEx ia IIC T4 approval for hazardous area application.

Other features included in the installed DOG flow meter are anti-corrosion paint and a suitable stainless steel meter run, in order for you to get a good measurement result.

Plus, to include process pressure and temperature variables into the calculation, we installed a PAS Pressure Transmitter and a TWL Temperature Transmitter whose outputs were connected to an external Flow Computer, along with the value received from the flowmeter.

The output we got derive from the above installation package is the corrected value of biogas volumetric flow both in flow rate value (Nm³/h) and total flow value (Nm³).





Applications

Cooling monitoring for Casting Machines

Task: Provide a proportional electrical output with visual indication of flow

The application is cooling water on casting machines with 96 channels. The casting machines are used to produce engine and steering parts, and are installed all over the world; Turkey, Germany, China, USA, Outer Mongolia, and Korea.

The original machines used a turbine flow sensor and separate flow indicator. The customer requested a change due to dirty water clogging the orifice of the turbine sensors.

Solution:

KOBOLD model DF series with an analogue output and clear paddlewheel cover. The reason for the DF is the ability to easily pass suspended solids and not clog and to function as a sight gauge. The DF passed with flying colours. The DF sensor casting manufacturer was able to eliminate both the turbine sensor and flow indicator with one sensor. The DF works well and has become the standard for the customer. The casting method used in this process is considered the best and most productive casting system available.



The DF paddle wheel flow sensor is a reliable and economical solution for monitoring flow of water like media where an output and visual indication is needed!

Heavy duty equipment needs protection you can count on

Task: Cone crusher lubrication monitoring



Mobile cone crushers are used to turn raw materials such as rocks, minerals, ores, reclaimed glass and ceramic into graded usable product. They are versatile and convenient, producing the materials needed for construction at the place where they are needed, saving time and cutting down on transport costs on large civil, mining and recycling projects.

The rocks are fed into a fixed cone which has a rotating eccentric cone inside it. By varying the gap between the cones, the size of product produced can be controlled. At the heart of a mobile cone crusher is the bearing assembly. This is subject to massive pressures, and vibrations, and the machines are used in harsh climatic conditions throughout the world, day in day out.

The bearing assembly is very expensive, is often time consuming to replace and subject to a long delivery time. Correct lubrication of the bearing assembly is therefore paramount to avoid costly downtime. Therefore a dependable means of monitoring the oil supply is required, that will work in extremes of temperature, and be as rugged and as reliable as the rest of the machine.

Solution:

The OVZ flow monitor from Kobold ticks all the boxes. It has a robust durable aluminium body and PMMA cover, which acts as a sight glass, allowing engineers to see at a glance that all is well with the precious oil flow. Its positive displacement technology means that it is viscosity compensated when subjected to temperature extremes. The electronics have been epoxy encapsulated for full protection from ingress or vibration. They combine a wide voltage supply range, DC-DC convertor with interference filter, for a faithful output signal allowing optimal lubrication control.

The OVZ offers great value insurance and accurate, reliable performance; whether used in Australia or Alaska!



Phosphate Precipitation in Waste Water Treatment Plants

Task:

By addition of Iron (III) Chloride (FeCl_3) in the aeration basin, the phosphates dissolved in excess waste water are chemically mixed with sludge flocculants and transferred with sludge to the sludge treatment stage.

This process reduces phosphate concentration in our waterways and therefore minimises the potential for abnormal algae growth, and the detrimental effect for the aquatic eco-system.

As an overdose of Iron (III) Chloride leads to a massive pollution of water, is injurious to humans and pollutes the environment, a completely dependable method of process monitoring is paramount. A continuous flow measurement of the dosing chemical with a direct data connection to your process control system guarantees you maximum safety; so that possible errors are not just discovered during sample taking, when it's too late.

Solution:

With the MIK magnetic-inductive flow meter, KOBOLD Messring GmbH offers you an optimal and economical solution for safe dosage of Iron (III) Chloride. The unit was specifically developed for this application and has already proven itself very successfully in service.

The device housing is made of PVDF, the electrodes in contact with the medium are made of tantalum. Both materials have proven to be totally chemically resistant. Together with the direct mounted transmitter with stainless steel housing, this device forms a very compact yet robust unit, which is ideal for fitting inside cramped control cabinets. It allows detection of very small dosage amounts from 10 ml/min!

With an analogue 4-20 mA signal (or optional pulse output) the MIK continuously communicates the measured values to your process control system, so that it allows immediate response to the latest process conditions.

This increases efficiency, saving cost in the amount of Iron Chloride required to achieve phosphate removal, and protection of the environment.

Automation guarantees high standards of plant safety even at unmanned plants!

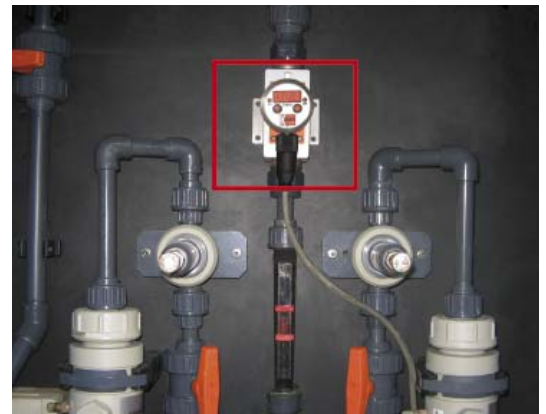

Air sparge systems for groundwater remediation

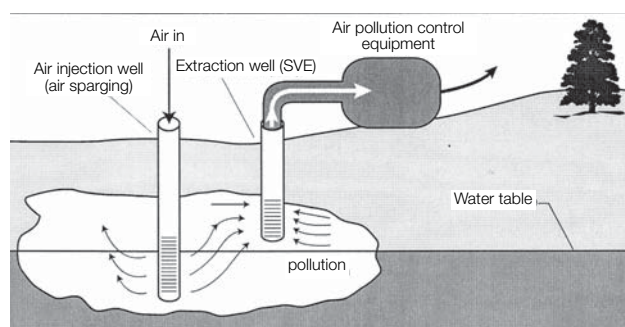

Task:

Inexpensive flowmeter to install in an air sparge field with multiple wells

Air sparging involves drilling multiple wells into a contaminated ground water pocket. Fresh air is forced into the groundwater in order to 'bubble' contaminants into the vapor pocket above the water. The contaminated air is pulled out of the pocket and treated. The sparge runs continuously until the ground water is free of contaminants.

Solution:

The customer needed an inexpensive flowmeter to install in an air sparge field (120 individual wells). The meter ensures sufficient air flow into the well. Preferred KSM series all plastic to minimize corrosion and reduce cost. We were recommended by one of the engineers in the firm due to excellent support on a past project. We were able to quickly ship some pieces for a test and the balance direct to site. Each sparge field uses anywhere from 100-150 meters.



The KSM is a safe and economical solution for ground water remediation monitoring!

Applications

Brewery - Instrumentation

Selected for you from the comprehensive KOBOLD product range



Flow

Measurement with or without moving parts

- Model DUJ: Ultrasonic Flow Meter/Switch
- Model KSM: Variable Area Flow Meter/Switch
- Model PSR: Paddle Flow Switch
- Model MIK: Magnetic Inductive Flow Meter
- Model DAA/DAH: Flow Indicator

Pressure

- Model MAN-R../-ZF: Bourdon Tube Pressure Gauge
- Model MAN-RF...DRM: All stainless steel Pressure Gauge with Diaphragm Seal, Capillary and Clamp Connection
- Model MAN-RF...M21...DRM: All stainless steel Contact Pressure Gauge with Liquid Damping, Diaphragm Seal and Dairy Connection
- Model PSC/PDD/PDA: Electronic Pressure Switch



Level

Level Switch/Meter

- Model NIR: Rotary Vane Level Switch (EX)
- Model NTB: Deep-well Probe
- Model NMT: Magnetostrictive Level Gauge
- Model LNM: Microwave Level Switch
- Model LNK: Conductive Level Switch
- Model NBK: Bypass Level Gauge
- Model LNP: Potentiometric Level Meter



Temperature

- Model LTS-NK: Temperature Probe Pt 100 compact version
- Model TNS-TNF: Safety Thermometer with Contacts
- Model TDD/TDA: Electronic Temperature Sensor/Switch



Turbidity and Conductivity

- Model ATL: Turbidity Sensor
- Model ATT-K: Transmitter
- Model LCI: Inductive Conductivity Measuring System



Hand-Held Units/Data Logger

For many different variables

- Model HND-T: for Temperature Measurement
- Model HND-F: for Humidity Measurement
- Model HND-P: for Pressure Measurement
- Model HND-C: for Conductivity Measurement
- Model HND-R: for pH, Redox, Temperature Measurement
- Model ZLS: Electronic Multi-Channel Data Logger





Model	Page	Model	Page	Model	Page	Model	Page	Model	Page
ACM	33	DRG	11-12	LFM	12	NUS	29	TNK	31
ACS	33	DRH	11	LNK	27, 34	NV	26	TNS	30
ADI	5, 8, 11-13, 36	DRM	22-23, 34	LNM	27, 34	NVI	27	TRS	30
AFA	33	DRS	6-7	LNP	28, 34	NWS	27, 34	TSA	31
AFK	33	DRZ	12	LNR	27	OME	13	TSK	6
AFS	33	DSS	5	LNZ	27, 34	OMG	13	TTD	32
ANU	15	DSV	4	LPS	6	OPT	27	TTE	32
APM	33	DTB	31	LTS	31, 34	OVZ	12	TTL	32
APS	33	DTK	10	LZE	27, 34	PAD	21-22, 29	TTM	32
ATA/ATS	33	DTM	31	MAN	20- 23, 34	PAS	24, 29	TUR	7
ATL	33	DUK	18	MAS	14	PDA	23	TUV	8
ATT	33	DUS	16	MFC	14	PDC	20	TWA	32
AUF	7-9, 11-12, 24-25, 31, 34, 36	DVE	17	MFF	36	PDD	25	TWD	31
BA	29	DVH	17	MFR	36	PDL	25	TWE	32
BGF	4	DVK	14	MIK	16	PEL	9	TWL	30, 32
BGK	4	DVT	16	MSR	36	PIT	16-17	TWM	32
BGN	4, 34	DVZ	17	MZB	25	PLS	28	TWR	30
BUS	36	DWD	6	M	26	PMP	21	UFJ	19
BVB	5	DWF	33	MM	28	PNK	22	URB	3
DAA/DAH	18	DWN	6	MS	26	PPS	6	URK	4
DAB	19	DWU	6	MWD	31	PSC	25	URL	3
DAF	19	DZR	13	NAB	26	PSE	5	URM	3
DAG	36	EDM	9	NAD	35	PSR	5	UTS	4
DAK	19	EPX	17	NBA/NBE	26	PUM	20	UVR/UTR	3
DAR	19	FPS	6	NBK	28-29	RCD	16	V31	3
DAT	19	HND	6, 21, 25, 31, 33	NCW	27	REG	18, 35	VKA	5
DAZ	19	KAH	14	NE	27	RFS	26	VKG	5
DF	10	KAL	13-14, 34	NEC	26	SCH	25	VKM	5
DFT	11	KDF/KDG	3	NEH	26	SEN	23- 25, 34	VKP	5
DIG	19	KDS	4	NEK	27	SFL	8	ZED	7-13, 36
DIH	19	KES	15	NES	26	SMN	5	ZLS	36
DKB	19	KFD	36	NEW	26	SMO/SMW	5	ZOK	36
DKF	19	KFF	10	NGM	29	SMV	5		
DMH	17, 34	KFR	3	NGR	29	SWK	4		
DMS	14	KLA	35	NGS	26	SZM	28		
DMW	14	KLP	35	NIR	28, 34	TBE	30		
DOC	13	KMP	31	NKP	26	TBI	30		
DOG	17-18	KMT	14-15	NMC	28	TDA	30		
DON	12-13	KPL	15	NMF	28	TDD	30		
DOR	12	KSK	3	NMT	28	TGK	30		
DOT	8	KSM	3	NPF	29	TGL	30		
DPE	7-8	KSR/SVN	3	NQ	27	TIR	30-31		
DPL	9-10	KSV	3	NSC	28, 34	TM	15		
DPM	9	KUG	23, 31, 35	NSE	26	TMA	31		
DPT	6	KUP	35	NSM	26	TME	15		
DRB	8	KUR	35	NSP	26	TMR	15		
		KZA	13	NST	26	TMU	15		
		LCI	33	NSV	27, 34	TND	30		
				NTB	29	TNF	30, 34		

Tri-Clamp® is a registered trademark of Tri-Clover Inc. of the Alfa-Laval Group.
 Ryton® is a registered trademark of Chevron Phillips Chemical Company.



 **Argentina**
KOBOLD Instruments S.A.
Florida - Buenos Aires
☎ +54 (0) 11 4760 8300
info.ar@kobold.com

 **Australia**
KOBOLD Messring GmbH
Sydney
☎ +61 (0) 428138232
ranjan@kobold.com

 **Austria**
KOBOLD Holding Ges.m.b.H.
Vienna
☎ +43 (0)1-786 5353
info.at@kobold.com

 **Belgium**
KOBOLD Instrumentatie NV/SA
Strombeek-Bever - Brussels
☎ +32 (0)2 267 2155
info.be@kobold.com

 **Bulgaria**
KOBOLD Messring GmbH
Sofia
☎ +359 2 9544 412
info.bg@kobold.com

 **Canada**
KOBOLD Instruments Canada Inc.
Pointe Claire, Quebec - Montreal
☎ +1 514-428-8090
info.ca@kobold.com

KOBOLD Instruments Canada Inc.
Mississauga, Ontario - Toronto
☎ +1 416-482-8180
info.ca@kobold.com

 **Chile**
KOBOLD Messring GmbH
Santiago
☎ +56 (2) 665 1643
info.cl@kobold.com

 **China**
KOBOLD Instruments
Trading Co., Ltd.
Pudong - Shanghai
☎ +86 (0)21 583 645 79
info.cn@kobold.com

KOBOLD Manufacturing Co., Ltd.
Xian
☎ +86 (0)29 86210794/86211407
wang@kobold.com

KOBOLD Instruments Trading
(Shanghai) Co. Ltd.
Tianjin
☎ +86 (0)22 83719393
hou@kobold.com

KOBOLD Instruments Trading
(Shanghai) Co. Ltd.
Guangzhou
☎ +86 (0)20 38803380
zhentx@kobold.com

KOBOLD Instruments Trading
(Shanghai) Co. Ltd.
Wuhan
☎ +86 (0)27 87132425
hushilei@kobold.com

KOBOLD Instruments Trading
(Shanghai) Co. Ltd.
An'hui
☎ +0551 65618167
wu@kobold.com

 **Czech Republic**
KOBOLD Messring GmbH
Brno
☎ +420 541 632 216
info.cz@kobold.com

 **Colombia**
KOBOLD Rep. Office Colombia
Bogota
☎ +57 313 852 00 88
restrepo@kobold.com

 **Egypt**
KOBOLD Messring GmbH
Nasr City - Cairo
☎ +202 2 273 1374
info.eg@kobold.com

 **France**
KOBOLD Instrumentation S.A.R.L.
Cergy-Pontoise Cedex - Paris
☎ +33 (0)1 34 21 91 15
info.fr@kobold.com

KOBOLD Instrumentation S.A.R.L.
Dardilly - Lyon
☎ +33 (0)4 72 16 21 94
rollin@kobold.com

 **Germany**
KOBOLD Messring GmbH
Hofheim/Taunus
☎ +49 (0)6192-299-0
info.de@kobold.com

KOBOLD Messring GmbH Werk II
Sindelfingen - Stuttgart
☎ +49 (0)7031-8677-0
maier@kobold.com

Heinrichs Messtechnik GmbH
Cologne
☎ +49 (0)221-497 08-0
info@heinrichs.eu

 **Hungary**
Kobold Unirota Kft.
Nyíregyháza
☎ +36 42 342-215
info.hu@kobold.com

 **India**
KOBOLD Instruments Pvt Ltd.
Pune
☎ +91 93 70 221 190
info.in@kobold.com

KOBOLD North India Region
New Delhi
☎ +91 95 60 028 453
delhi.in@kobold.com

KOBOLD West India Region
Gujarat
☎ +91 97 12 233 533
gujarat.in@kobold.com

 **Indonesia**
KOBOLD Messring GmbH
Jakarta
☎ +62 21 849 328 59
info.id@kobold.com

 **Italy**
KOBOLD Instruments S.r.l.
Settimo M.se - Milan
☎ +39 02 33 572 101
info.it@kobold.com

 **Malaysia**
KOBOLD Instruments SDN BHD
Puchong, Selangor
☎ +60 (0)3 8065 5355
info.my@kobold.com

 **Mexico**
KOBOLD Instruments Inc.
Querétaro
☎ +52 442 295 1567
info.mx-mex@kobold.com

 **Netherlands**
KOBOLD Instrumentatie BV
Arnhem
☎ +31 (0)26-384 48 48
info.nl@kobold.com

 **Peru**
KOBOLD Perú SAC
Lima
☎ +51 13307261
info@koboldperu.com

 **Poland**
KOBOLD Instruments Sp.z o.o.
Warsaw
☎ +48 (0)22 666 18-94
info.pl@kobold.com

KOBOLD Instruments Sp.z o.o.
Gliwice
☎ +48 730 202 100
info.pl@kobold.com

 **Republic of Korea**
KOBOLD Instruments Co., Ltd.
Koyang-City, Kyounggi-do
Seoul
☎ +82 (0)31 903521-7
info.kr@kobold.com

 **Romania**
KOBOLD Messring GmbH
Bucharest
☎ +40 21 456 05 60
info.ro@kobold.com

 **Russia**
OOO KOBOLD Instruments
Moscow
☎ +7 (499) 346-70-10
info.ru@kobold.com

 **Singapore**
KOBOLD Messring GmbH
Singapore
☎ +65 6227 1558-6366
info.sg@kobold.com

 **Slovakia**
KOBOLD Messring GmbH
Brno
☎ +420 541 632 216
info.cz@kobold.com

 **Spain**
KOBOLD Mesura S.L.U
Badalona - Barcelona
☎ +34 (0)934 603 883
info.es@kobold.com

 **Switzerland**
KOBOLD Instruments AG
Dübendorf - Zurich
☎ +41 (0) 44-801 9999
info.ch@kobold.com

 **Taiwan**
KOBOLD Messring GmbH
Taipei City
☎ +886 (0)2 8792 6335
info.tw@kobold.com

 **Thailand**
KOBOLD Instruments Ltd.
Bangkok
☎ +66 (0)2 565 5705-6
info.th@kobold.com

 **Tunisia**
KOBOLD Messring GmbH
Tunis
☎ +216 7134 1518
info.tn@kobold.com

 **Turkey**
KOBOLD Instruments Ltd.
Istanbul
☎ +90 212 222 23 07
info.tr@kobold.com

 **United Kingdom**
KOBOLD Instruments Ltd.
Mansfield - Nottinghamshire
☎ +44 (0)1623 427 701
info.uk@kobold.com

 **USA**
KOBOLD Instruments Inc.
Pittsburgh, PA
☎ +1 412-788-2830
info@koboldusa.com
info.usa@kobold.com

KOBOLD Eastern Region
Providence, RI
☎ +1 401-829-1407
tcummins@koboldusa.com

KOBOLD Mid-Atlantic Region
Medina - Cleveland, OH
☎ +1 412-389-1111
gkeller@koboldusa.com

KOBOLD Western Region
Boulder City - Las Vegas, NV
☎ +1 702-994-2156
dgoss@koboldusa.com

KOBOLD Mid West Region
Clinton, Twp. - Detroit, MI
☎ +1 586-321-7227
tkelly@koboldusa.com

KOBOLD South-Eastern Region
☎ +1 412-788-2830
info@koboldusa.com

 **Vietnam**
KOBOLD Messring GmbH
Ho Chi Minh City
☎ +84 (0)8 3551 0677
info.vn-hcm@kobold.com